

DECEMBER 1929

RADIO BROADCAST

PUBLISHED FOR THE RADIO INDUSTRY



SPECIAL FEATURES IN THIS ISSUE

How Good Should Radio Sets Be Made?

Measurements on Electrostatic Loud Speakers

The Philco 95 Receiver

How Much Radio Advertisers Spend • What Is the Future of the Jobber? • A Survey of Time Payments •
The Mergers in Radio? • Tested Sales Ideas • The Cut Price Evil • General Motors and Radio

THIRTY FIVE CENTS

DUNN, DORAN & CO., INC. ♦ GARDEN CITY, NEW YORK

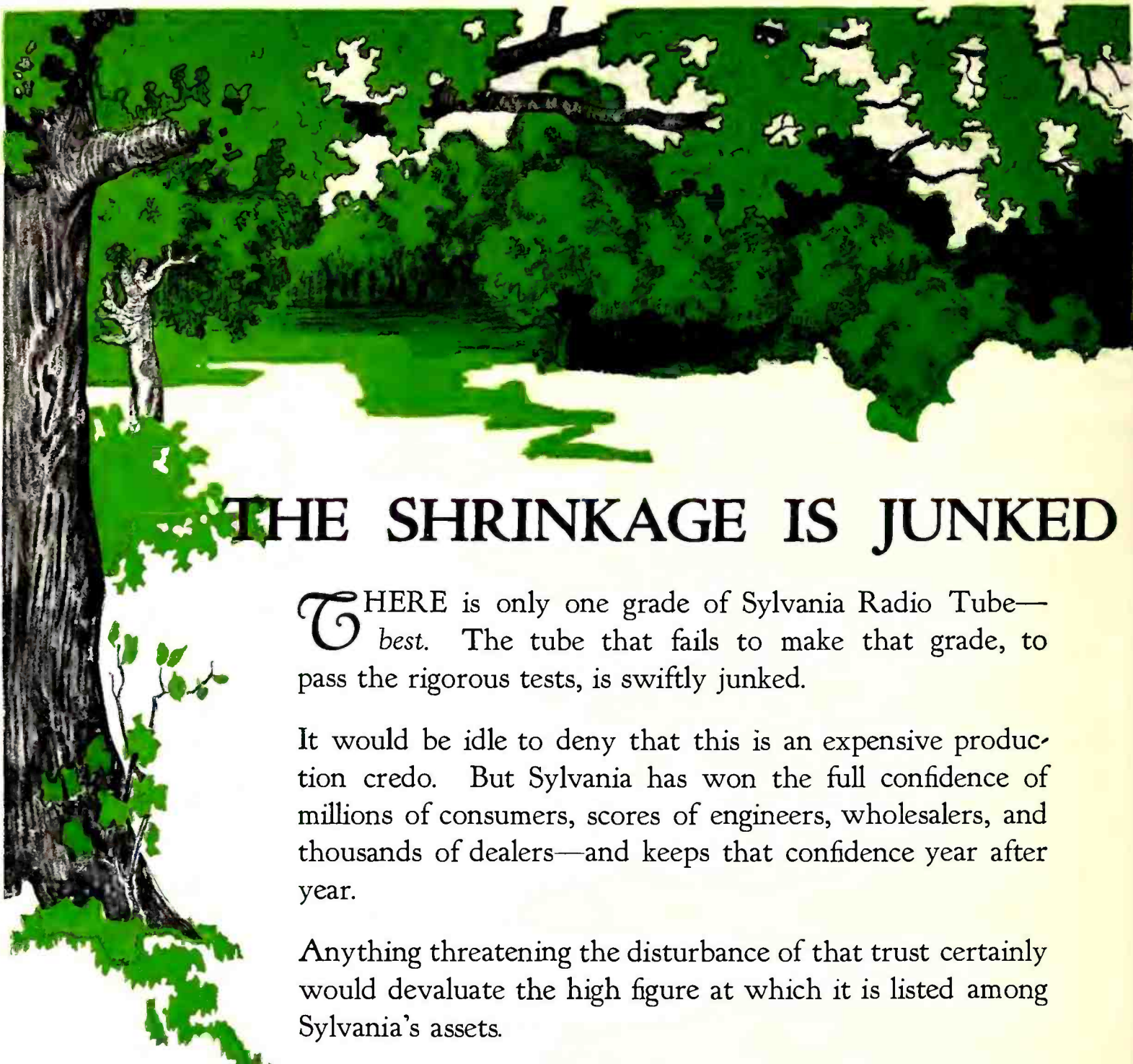

THE SHRINKAGE IS JUNKED

HERE is only one grade of Sylvania Radio Tube—
best. The tube that fails to make that grade, to
pass the rigorous tests, is swiftly junked.

It would be idle to deny that this is an expensive produc-
tion credo. But Sylvania has won the full confidence of
millions of consumers, scores of engineers, wholesalers, and
thousands of dealers—and keeps that confidence year after
year.

Anything threatening the disturbance of that trust certainly
would devalue the high figure at which it is listed among
Sylvania's assets.

And so, every Sylvania Radio Tube is the very finest tube
that our engineers can produce.

No seconds for sale!

SYLVANIA PRODUCTS COMPANY

Emporium Pennsylvania

*The home of the Sylvania Foresters who are heard each week over
WJZ, KDKA, KWK, KYW, WBZ, WBZA, WBT, WHAM,
WJR, WLW, WREN, WRVA, KGRC, KPRC, WFAA, KFJR,
WCCO, WHK.*

Sylvania

RADIO TUBES

Licensed Under RCA Patents



HERALDING



THE NEW LEADER IN REPRODUCTION

Amplifiers by an acknowledged leader in the audio field are indispensable where better quality, greater power output, or both, are required. Thordarson power amplifiers meet these requirements, combining all the features of design gathered by years of research and experience in Thordarson laboratories.

Special Features:

1. **Fidelity**—These amplifiers incorporate the best of Thordarson audio transformers, properly designed to give uniform amplification over the useful audio range.
2. **Output**—Maximum undistorted output 4650 milliwatts.
3. **Amplification**—Voltage amplification of 275.

4. **No Hum**—Hum has been reduced to absolute minimum.

5. **Design**—The work of many months by Thordarson engineers backed by years of experience.

6. **Adaptability**—Ingenious means for applying this amplifier to any problem in sound reproduction.

7. **Simplicity**—Self-contained, no outside terminals.

8. **Safety**—Completely fused and equipped with automatic safety switch.

9. **Workmanship**—In keeping with Thordarson products.

10. **Attractive Appearance**—Finished in gold lacquer.

11. **Guarantee**—Liberal 90-day guarantee.

12. **License**—Licensed by Radio Corporation, Bell Telephone, General Electric, Westinghouse and Thordarson.

13. **Price**—\$89.50.

DISTRIBUTORS

Boston, Mass. Woodrow Radio Co. 166 Prospect Street Cambridge, Mass.	Cleveland, Ohio M & M Co. 500 Prospect Avenue
Chicago, Ill. Newark Electric Co. 226 W. Madison St.	Dayton, Ohio Burns Radio Co. 12-20 Jefferson St.
Chicago, Ill. Chicago Radio Apparatus Co. 415 S. Dearborn St.	New York City, N. Y. Graymore Radio Corporation 142 Liberty St.

THORDARSON

POWER AMPLIFIERS

DISTRIBUTORS

Philadelphia, Pa. M & H Sporting Goods Co. 512 Market St.	Minneapolis, Minn. Jalisco Mfg. Co. 229 E. Hennepin Ave.
Pittsburgh, Pa. Cameradio 430 Wood Street	Seattle, Wash. Wedel Co. 520 2nd Avenue
Minneapolis, Minn. Findley Electric Co. 111 S. 6th St.	St. Louis, Mo. Van Ashe Radio Co. 210 N. 10th St.
	St. Paul, Minn. Pioneer Electric Co. 137 E. Fifth St.

THORDARSON ELECTRIC MFG. CO., Huron, Kingsbury and Larrabee Sts., Chicago, Ill.



HIGH-QUALITY,
DEPENDABLE TUBES
FOR
TALKING
PICTURES
AND
TELEVISION



EVEREADY Raytheon Television Tubes are the result of our extensive research and experience in this new science. Their construction is along the same advanced lines which give all Eveready Raytheon Tubes their well-known superior performance.

The Eveready Raytheon Foto-Cell is a long-life, sensitive, quick-response transmitting tube for talking pictures. Used also in television. It is made in several types for different requirements. Foto-Cells to special specifications will be made at reasonable prices.

The Eveready Raytheon Kino-Lamp for television reception is the first tube developed commercially which will work with all systems. Uniform glow over the entire plate, perfect reproductive qualities without the need of mirrors or ground glass, tested performance . . . are features which make this tube outstanding.

Correspondence is invited from every one interested in television and talking pictures.

NATIONAL CARBON CO., INC.
General Offices: New York, N. Y.
Branches: Chicago Kansas City
New York San Francisco
Unit of  and Carbon Corporation



WHEN
CONTROL
IS EVERYTHING—

Storm, sleet, fog, darkness . . . the airplane pilot must "carry on."

At such a time Control is everything. Your radio must "Carry on" whenever you snap the switch.

Your control (volume control) must function smoothly . . . easily . . . consistently if you would be rewarded with clear-sounding entertainment. Your radio will do just that if it is CENTRALAB equipped.

Write for free booklet "Volume Controls, Voltage Controls, their uses."

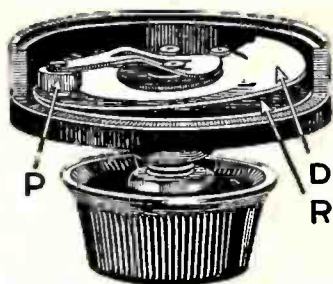

This shows the exclusive rocking disc construction of Centralab volume control. "R" is the resistance. Contact disc "D" has only a rocking action on the resistance. Pressure arm "P" together with shaft and bushing is fully insulated.

Centralab

CENTRAL RADIO LABORATORIES
20 Keefe Ave. Milwaukee, Wis.

Power Detection
Of an Advanced Design

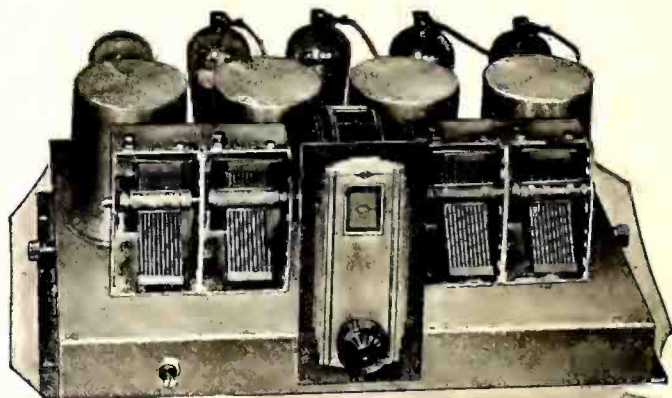

A new form of power-detection is used in the NATIONAL Screen Grid MB-29 Tuner, in which the grid-bias voltage is not modulated by the plate current.

This gives all the recognized advantages of power-detection, which gets the most out of the modern high-percentage broadcast modulation, yet without sacrificing as much sensitiveness as with the more usual type.

In addition, the MB-29 uses 4 Screen Grid A. C. Tubes, Band Pass tuning, Coils precision-matched to 1-10th of one per cent, the new NATIONAL Projector Dial with rainbow color feature and opalescent Dial-screen, and a beautifully finished aluminum chassis.

Write us for more complete technical information, mentioning Radio Broadcast.

NATIONAL CO. INC., Malden, Mass.

Est.  1914

NATIONAL
SCREEN-GRID— **MB-29**

SM

One Mile from WSM— 400 from WMAQ—and the 712 Cuts 20 kc.!

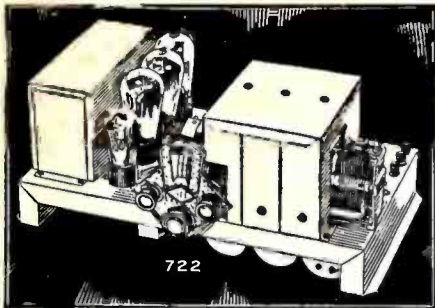

722 Band Selector Seven

Providing practically all 1930 features found in most new \$200 receivers, the S-M 722 is priced absurdly low in comparison. 3 screen-grid tubes (including detector), band filter, 245 push-pull stage—these help make the 722 the outstanding buy of the year at \$74.75 net, completely wired, less tubes and cabinet. Component parts total \$52.90. Tubes required: 3—'24, 1—'27, 2—'45, 1—'80.

Beautiful Cabinets

The handsome new 707 table model shielding cabinet, finished in rich crystalline brown and gold, suitable for 722, 735, or 735DC, is only \$7.75. Special arrangements have been made whereby these receivers may be housed in magnificent consoles especially adapted to them. Be sure to send for the new Fall S-M General Parts Catalog, for details of these cabinets.

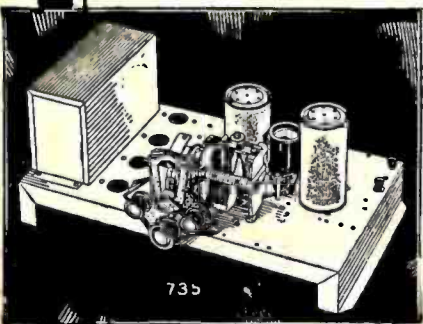

Keep up-to-date on Silver-Marshall progress; don't be without THE RADIOBUILDER. New products appear in it in advance of public announcements. The October 15th issue, for example, described a new amplifier design for television reception, as well as hints on installing the wonderful 712 as the radio tuner unit in rack-and-panel installations. If you're not getting THE RADIOBUILDER regularly—use the coupon!

Big Opportunities This Year for S-M Service Stations

Custom-builders using S-M parts have profited tremendously through the Authorized S-M Service Station franchises. Silver-Marshall works hand-in-glove with the more than 3000 professional and semi-professional builders who display this famous insignia. If you build professionally, let us tell you all about it—write at once!

SILVER-MARSHALL, Inc.

6403 West 65th St., Chicago, U. S. A.

W. W. DILLON & CO.

Realtors, Nashville, Tennessee

"Silver-Marshall, Inc., Chicago:

"I have had your 712 tuner for about ten days now ... over a hundred stations have been received ... I live within a mile of the towers of WSM (650 kc.) but am able to bring in WMAQ (Chicago, 670 kc.) and KPO (Oakland, Calif., 680 kc.) ... I find I get results on a short indoor aerial which you claim only when using a longer outdoor antenna ... I am using 30 feet of rubber-covered wire tacked up in the attic ... Some night I may put up a decent aerial, connect it as you direct and bring in China."

—M. G. Horkins

The custom-built S-M 712 used by Mr. Horkins is a straight one-dial all-electric tuner, as easy to operate as the cheapest radio. Whether it's a world-beating set for your own home, or a custom design to build for "fastidious listeners"—the S-M 712 so far overshadows competition that comparison becomes ludicrous.

And if You Prefer a Still Lower Cost—

"Silver-Marshall, Inc., Chicago:

"I received my 722 ... That receiver is certainly the best for the money—KDKA or WBZ without any heterodyning at blasting volume, or WRVA and WPG, or WJZ and WBBM, or WEA and WMAQ. (All four are 10 kc. separations.) WJZ, WGY, KDKA and CKAC, 400 to 600 miles away, are regular daylight features ... I will keep on boosting Silver-Marshall sets like I have been doing since four years ago."—Gleason Belzile, Rimouski, Quebec, Canada.

Short Wave Reception Without Batteries

A screen-grid r. f. stage, new plug-in coils covering the bands from 17 to 204 meters, regenerative detector, a typical S-M audio amplifier, all help to make this first a. c. short-wave set first also in performance. Price, wired complete with built-in power unit, less cabinet and tubes, only \$64.90. Component parts total \$44.90. Tubes required: 1—'24, 2—'27, 2—'45, 1—'80. Two extra coils, 131P and 131Q, cover the broadcast band at an extra cost of \$1.65.

Adapted for battery use (735DC) price, \$44.80, less cabinet and tubes. Component parts total \$26.80. Tubes required: 1—'22, 4—'12A. All prices net.

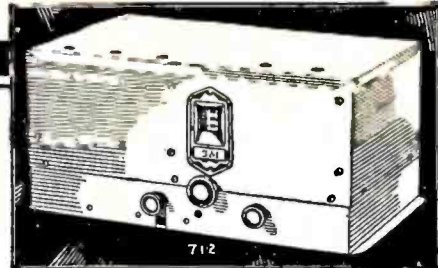

The New "Boss of the Air"—S-M 712

Far more selective and sensitive even than the Sargent-Rayment 710, the new all electric single control 712, with band-filter and power detector, stands far beyond competition regardless of price. Feeds perfectly into any audio amplifier, the S-M 677 being especially suitable and convenient. The 712 can be easily mounted for use as radio tuner in a rack-and-panel amplifier installation; the superlative quality of its reception makes it ideal for this purpose, while the low-impedance power detector works perfectly into any type of power amplifier. Tubes required: 3—'24, 1—'27. Price, only \$64.90, less tubes, in shielding cabinet. Component parts total \$40.90.

677 Amplifier

Superb push-pull amplification is here available for only \$58.50, less tubes. Ideal for the 712, since it furnishes all required power (180 volts B, 2½ volts A.C.). Tubes required: 2—'45, 1—'27, 1—'80. Component parts total \$43.40.

Silver-Marshall, Inc.
6403 West 65th Street, Chicago, U. S. A.

Please send me, free, the new Fall S-M Catalog; also sample copy of The Radiobuilder.

For enclosed.....in stamps, send me the following:
..... 50c Next 12 issues of The Radiobuilder
..... \$1.00 Next 25 issues of The Radiobuilder.

S-M DATA SHEETS as follows, at 2c each:

-No. 3. 730, 731, 732 Short-Wave Sets
-No. 4. 255, 256, etc., Audio Transformers
-No. 5. 720 Screen Grid Six Reeliver
-No. 6. 740 "Coast-to-Coast" Screen Grid Four
-No. 7. 675ABC High-Voltage Power Supply
-No. 8. 710 Sargent-Rayment Seven
-No. 9. 678PD Phonograph-Radio Amplifier
-No. 12. 669 Power Unit
-No. 14. 722 Band-Selector Seven
-No. 15. 735 Round-the-World Six
-No. 16. 712 Tuner (Development from the Sargent-Rayment)
-No. 17. 677 Power Amplifier for use with 712

Name.....

Address.....

RADIO BROADCAST

WILLIS KINGSLEY WING Editor
KEITH HENNEY Director of the Laboratory
HOWARD E. RHODES Technical Editor
EDGAR H. FELIX Contributing Editor



VOL. XVI. NO. 2

PUBLISHED FOR THE RADIO INDUSTRY

Contents for December, 1929

General Motors—And Radio	71
Changing Sales Conditions <i>Harry P. Bridge</i>	72
Radio's Advertising Budget—\$25,000,000 <i>T. A. Phillips</i>	74
What Is the Size of Your Slice? <i>Howard W. Dickinson</i>	76
The Jobber's New Place <i>A. H. Deutz</i>	78
Tested Sales Ideas <i>Merchandising Shorts</i>	80
Field Crew Directed From Truck Inexpensive Publicity that Counts When Dealers Coöperate Making Money Out of Trade-ins	Try This Stunt in Your City Sell a Set to Your Doctor Making Outside Salesmen Pay Increasing Service Efficiency
How About Time Payments? <i>Howard W. Dickinson</i>	82
Professionally Speaking <i>Keith Henney</i>	84
Regarding Style Changes A Radio for the Farmer	Foreign Views on Advertising
House-to-House Selling Is Not a Sideline <i>Bayard B. Penrose</i>	85
Radio Pictures of the Month <i>A Page of Pictures</i>	87
Advertise What You Have to Sell	88
The March of Radio <i>An Editorial Interpretation</i>	90
Readjustment in the Industry What is Right with Broadcasting	Roasting Will Do It. A Lesson for the Radio Industry
News of the Radio Industry	92
The Tube Business <i>News of the Tube Industry</i>	96
Strays from the Laboratory <i>Technical Shorts</i>	101
Regarding Synchronized Stations	Measuring Screen-Grid Capacity
In the Radio Marketplace <i>Offerings of Manufacturers</i>	102
The Serviceman's Corner	104
Electrostatic Loud Speakers <i>F. J. Somers and G. E. Matlos</i>	106
Setting Radio Standards <i>Kenneth W. Jarvis</i>	108
The Philco "95" Screen-Grid Plus <i>Waller E. Holland and W. A. MacDonald</i>	111
The Electrodynamic Loud Speaker <i>E. A. Uehling</i>	113
Development of the Pentode Tube <i>Friedrich Oskar Rothy</i>	116
"Radio Broadcast's" Set Data Sheets	118
The Crosley Models 609,610	The Day-Fan Model 5091
Radio Broadcast Laboratory Information Sheets— <i>Howard E. Rhodes</i>	120
No. 307. Frequency Band Re- quirements	No. 308. Frequency Band Re- quirements No. 309. Volume vs. Fidelity

The contents of this magazine are indexed in *The Readers' Guide to Periodical Literature*, which is on file at all public libraries

. . . among other things

GREAT RADIO hue and cry has been raised recently. Will the purging of Wall Street affect the radio market? There are prophets who stoutly maintain opposite positions. Sales of radios, automobiles, fine looks, and whatnot will have a greatly restricted demand, one group says. The other says that radio sales are not influenced to any great degree by conditions on Wall Street. With this latter opinion, we agree. What of the fact that radio sales since the latter part of September and through most of October have shown a tendency to slow up? What of the rather general decrease in factory production of sets? What do the many announcements of sweeping price cuts mean?

ONE THING is certain: public interest in radio programs and radio merchandise is keen. Replacement tube sales continuing at a high level indicate that. But radio manufacturers have not yet learned how to gauge production to meet demands; they have not yet faced certain well-known and particularly serious distribution problems. Until the industry does this, each year is going to show a hurried readjustment of industry activity.

THIS MONTH the leading article in our department, "Professionally Spcaking" brings up a question that is worth some thought: "To what extent are changes in radio receivers due to engineering advances and to what extent is pure 'styling' responsible?" Can you name any change in radio design for which style is primarily responsible?

READERS have been insisting for months that the "Home-Study Sheets" return to the pages of RADIO BROADCAST. Effective with our January issue, this feature will reappear. January will also see an increase in the number of Set Data Sheets with the addition feature of proper voltage and current readings to help those who use these circuits in regular service work with a test set.

IN JANUARY, we plan to present an interesting article on one of the remote-control systems which will be in the public eye in a few more months. Among the other features will be a description of the new RCA farm radio set, the Radiola No. 21, an interesting review of merchandising and engineering radio progress for the year 1929, and a description of an unusual radio merchant who makes his service department pay and pay well.

—WILLIS KINGSLEY WING.

TERMS: \$4.00 a year; single copies 35 cents; All rights reserved. Copyright, 1929, in the United States, Newfoundland, Great Britain, Canada, and other countries by

DOUBLEDAY, DORAN & COMPANY, INC., Garden City, New York

MAGAZINES
COUNTRY LIFE WORLD'S WORK THE AMERICAN HOME RADIO BROADCAST SHORT STORIES LE PETIT JOURNAL EL ECO WEST
BOOK SHOPS (Books of all Publishers)

NEW YORK: <LORD & TAYLOR, JAMES McCREERY & COMPANY, PENNSYLVANIA TERMINAL, 166 WEST 32ND ST., 848 MADISON AVE., 51 EAST 44TH STREET, 420, 526, and 819 LEXINGTON AVENUE, GRAND CENTRAL TERMINAL, 10 WALL STREET> ATLANTIC CITY: <2807 BOARDWALK> CHICAGO: <75 EAST ADAMS STREET> ST. LOUIS: <223 N. 8TH ST. and 4914 MARYLAND AVE.> CLEVELAND: <HIGHBEE COMPANY> SPRINGFIELD, MASS: <MEEKINS, PACKARD & WHEAT.

OFFICES

GARDEN CITY, N. Y. NEW YORK: 241 MADISON AVENUE. BOSTON: PARK SQUARE BUILDING. CHICAGO: PEOPLES GAS BUILDING. SANTA BARBARA, CAL. LONDON: WM. HEINEMANN, LTD. TORONTO: DOUBLEDAY, DORAN & GUNOY, LTD.

OFFICERS

F. N. DOUBLEDAY, Chairman of the Board; NELSON DOUBLEDAY, President; GEORGE H. DORAN, Vice-President; RUSSELL DOUBLEDAY, Secretary; JOHN J. HESSIAN, Treasurer; LILLIAN A. COMSTOCK, Ass't Secretary; L. J. McNAUGHTON, Ass't Treasurer



PAM music in Peruvian park

MIKID

In the Zoological Gardens at Lima, Peru (pictured above), and all over the world, you will find PAM Amplified entertainment enhancing the beauties of nature.

PAM'S crystal clear voice can be suited to blend with forest sounds or increased to be easily heard above the roar of motors at air meets.

All around you are opportunities of a similar nature.

These opportunities are found in hotels, clubs, excursion steamers, schools, hospitals, parks, theatres, auditoriums, dance halls, skating rinks and swimming pools, air ports, ath-

letic fields, boat races, outdoor services, etc.

To the pioneer dealer who first sees and grasps this opportunity in his locality comes the greater volume and profit.

A new 16-page bulletin giving mechanical and electrical characteristics, representative installations and many new PAM Amplifiers will be sent upon receipt of 10 cents in stamps to cover postage. When writing ask for Bulletin No. RB13.

Main Office:
Canton, Mass.

Samson Electric Co.

MEMBER
RMA

Manufacturers Since 1882

Factories: Canton and
Watertown, Mass.

"TUBE SALES JUMP"

7-SECOND ACTION
 Don't just talk about Arcturus' starting speed... let your customer hold the watch.



SAY THOUSANDS OF ARCTURUS DEALERS WHO SELL TUBES THIS NEW, CONVINCING WAY

Here's one A-C tube that is good enough to sell on *proved performance* instead of sales talk.

CLEAR, HUM-LESS TONE
 Nothing you can say about Arcturus' clear tone is as convincing as a two-minute demonstration.



Its superiority is so evident that you can *show* your customers why it is better.

Just make the three easy tests shown in these photographs. Compare Arcturus performance with other A-C tubes, if you like. No question which tube your customers will buy.

LONG LIFE
 Show your customer, on the meter, that Arcturus Tubes easily withstand 75% more current than they are designed for. Then he will *know* why they hold the world's record for long life.



Remember that Arcturus Radio Tubes help your business in many ways. Arcturus quality keeps your customers satisfied... Arcturus dependability holds your service costs down.

There's profit in the proved performance of Arcturus *Long Life* Tubes. *Demonstrate* their quality... and put your tube and set business on a better basis than before.

ARCTURUS RADIO TUBE COMPANY
 Newark, N. J.

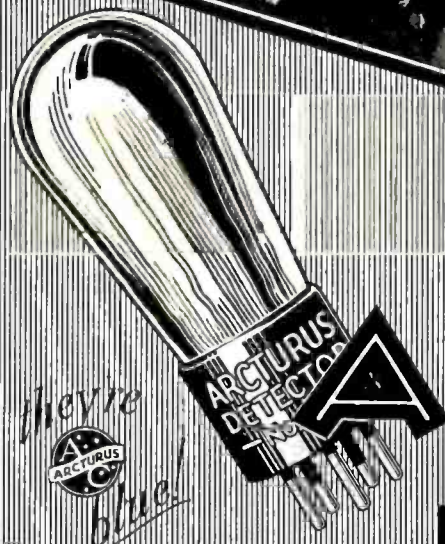

ARCTURUS A-C RADIO TUBES

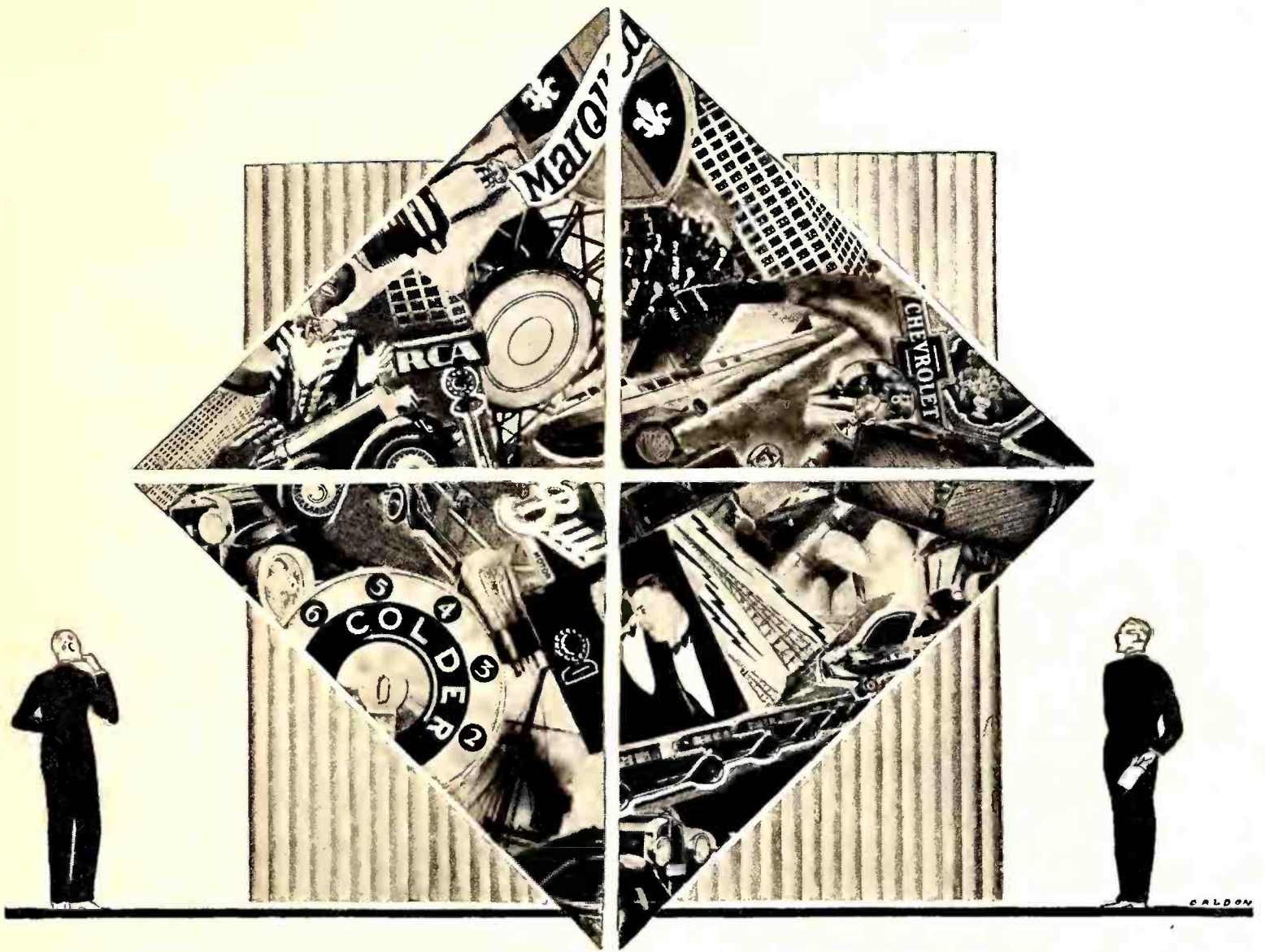

GENERAL MOTORS —AND RADIO

A NEW STAR has risen in radio. It is called the General Motors Radio Corporation, and early in October it was incorporated in the state of Delaware for \$10,000,000. The new company will manufacture and distribute apparatus covered by all the "Radio Group" patents "in radio, sound, and picture receiving and reproducing sets for use in homes and automobiles."

General Motors owns fifty-one per cent. of the \$10,000,000 of capital stock and Radio Corporation, forty-nine per cent. Management of the new corporation, as announced jointly by David Sarnoff, for RCA, and Alfred P. Sloan, Jr., for General Motors, will be in the hands of General Motors.

Nine men comprise the Board of Directors of which five are connected with the General Motors organization, two with the RCA, one representing Westinghouse, and one General Electric. The directors are:

- John Thomas Smith, vice president and general counsel General Motors Corporation (chairman of Board).
- R. J. Emmert, president, General Motors Radio Corporation.
- James G. Harbord, president, Radio Corporation of America.
- John L. Pratt, vice president, General Motors Corporation.
- A. W. Robertson, chairman, Westinghouse Electric & Manufacturing Co.
- David Sarnoff, executive vice president, Radio Corporation of America.
- Alfred P. Sloan, Jr., president, General Motors Corporation.
- Gerard Swope, president, General Electric Company.
- C. E. Wilson, vice president, General Motors Corporation.

It is understood that General Motors will direct the new company through a separate executive personnel not yet announced.

The new company will have the widest manufacturing scope under the patents to which it has access. Radio receiving sets for home use, the superheterodyne circuit, electric phonographs, combination radio-phonographs, radio sets for automobile installation, and apparatus for still and motion pictures are all covered in the patents available for use by the General Motors Radio Corporation.

No official of any of the four companies represented in General Motors Radio has been willing to comment on how the products of the new company will be distributed. It is apparent at this time, however, that products of General Motors Radio will be separately designed, separately manufactured, bear a separate trade identity, and, unless some new development is uncovered, will be separately merchandised.

In an announcement to all Radiola distributors, J. L. Ray, president of Radio-Victor, says: "The Radio Corporation of America and its wholly owned subsidiary companies will continue independently as heretofore, to manufacture and distribute their own products. The General Motors Radio Corporation will manufacture its own product and develop its own distribution."

(Concluded on page 122)

This Retailer Is Meeting

CHANGING SALES CONDITIONS



HOW—

Entertainment, Not Radio Is Sold

His Salesmen Sell Constantly

All Store Visitors Are Prospects

No "Cold Turkey" Canvassing

Prospect Leads From Service Calls

By HARRY P. BRIDGE, JR.

LET'S TAKE a good look at the man behind the radio counters of to-day and compare him with the type which will probably be there on the to-morrow that is already beginning to dawn. And to do this, let's go to the Universal Radio Company at the busy corner of Juniper and Arch streets, Philadelphia, Pennsylvania.

"Like the famous old gray mare, radio selling is not what it used to be," says Victor E. Moore, vice president and general manager of this concern. "In years gone by, when demand exceeded supply, radio literally sold itself. New developments made repeat buyers out of old customers without any great selling effort on the dealer's part.

"Now this spontaneous market is almost a thing of the past. Much of the novelty of radio has worn off; people have become more or less accustomed to it, and it has developed into a selling proposition much like the automobile, furniture, insurance, real estate, or any other legitimate business. And, more so now than ever before, radio is in need of that kind of selling."

Three Types of Men

There are, in this dealer's opinion, three types of men engaged in radio selling to-day—high-pressure artists, low-pressure men, and salesmen who strike a happy medium between the two. Much of Mr. Moore's time has been devoted to selecting men of the latter class for his organization—or those of the former type who could be led to change their ways.

"In building for the future," says Mr. Moore, "the high-pressure man is almost as useless as the fellow who has no sales pressure at all. The former relies on one-time sales to customers who don't come back and the latter lets perfectly good sales slip through his fingers because he lacks initiative. There are a lot of both engaged in retail selling to-day and the dealer's

problem in building a really aggressive and alert sales organization is not an easy one."

Mr. Moore chooses his men carefully, but his work does not end with the selection. That is only the beginning. He believes it is just as important for the retailer to exercise close supervision over the selling efforts of his organization as it is for the manufacturer or wholesaler. Every effort is made to help each man increase his efficiency and thus add to his own earnings as well as those of the company. But, if a man cannot fill the bill, the sooner this is discovered and the man dropped, the better it is for all concerned.

A Salesman Loses His Head

Not long ago, a Universal Radio Company salesman was on the point of closing a sale for a radio-phonograph combination. The outfit had been demonstrated in the home of a well-to-do woman and she was well pleased. However, when the salesman produced the contract for her signature, she said she had decided to hear one more outfit from another dealer before making a final decision.

"My salesman lost his head when he heard this," said Mr. Moore in describing the incident. "He'd been having a little run of hard luck and I had been after him to produce some sales. This one had seemed so sure he got rattled when he suddenly found there was still a chance that it might be lost. Putting the rectifying tube in his pocket he told her there would be no further concerts until she decided to buy. He added that

The Universal Radio Company's store at the busy corner of Juniper and Arch Streets, Philadelphia, Pa.



The large show room in the Universal store where several makes of radio receivers are attractively displayed.

the truck would call for the set in the morning unless she decided in the meantime.

"Well, for the salesman to lose his head in this manner was the best possible way to get the prospect to do the same thing. As a result she called on the phone, to tell us we didn't need to wait until morning to get the set. I immediately went out to see her myself, apologized for the salesman's action, restored the missing tube and, by the time the other dealer arrived, I was leaving with the contract signed. It is often very easy to come to an understanding from a misunderstanding such as this, and that is exactly what had happened. But that is not the point. The important problem was what to do with the offending salesman.

"He had not been with us long and my natural inclination was to let him go. However, I had thought the man had possibilities when I hired him and still thought so. Good salesmen are not easy to get and if one has good in him, I have found it worth while to try and bring it out.

"Accordingly, I called the fellow into my office and had a heart-to-heart talk with him. I told him there were two things he would have to do. First, he was to go to that lady and apologize and, second, he was to keep a better grip on his temper. In the third place, I told him he was going to get the commission, for, even though he had not really made the sale, he had done most of the work.

"The plan worked. The salesman felt he was as good as 'fired' when I called him into the office, but he was ready and willing to make good if he were given another chance. Within the next couple of days, he sold two expensive sets and to-day he is one of the best salesmen on our staff."

Careful Sales Supervision

Despite its central city location, the Universal Radio Company would not be so successful to-day were it not for salesmanship and sales supervision of a high order. As a single instance of this may be taken the answer to the old query: "What does a salesman do when he isn't selling?"

At the Universal Radio Company, there is no time when the salesman is not directly engaged in trying to make a sale. Salesmen are paid for their ability in that direction. Other jobs are left to other men. Mr. Moore's sales staff consists of five carefully selected men. Only one is to be found on the floor at any time during the day. The rest are kept busily engaged calling on their own prospects as well as those whose names are furnished by the firm. If there is a sudden rush of business at the store, Mr. Moore "pinch hits" and additional

recruits can be had from the service department as needed. This arrangement has proved particularly helpful in connection with the manager's ideas on using up-to-date methods for selling radio.

By a little tactful handling, the names and addresses of all people who visit the store are obtained. Then, if an interested party does not come back within a reasonable time, the salesman who met him does not delay. Out he goes to visit the prospect at his home—and frequently he comes back with the latter's request for a home demonstration.

Many leads are obtained by the company as a result of its advertising as well as the activities of servicemen who are almost as adept at searching out prospects as they are at fixing balky outfits. These are allotted among the salesmen who are required to report on each visit. Naturally these leads do not result in as many sales proportionately as the prospect list of those who have already visited the store. But such selling has proved well worth while. Incidentally, no "cold-turkey" canvassing is done.

Salesmen Sell Entertainment

Save in a few instances, where customers are technically inclined, Universal Radio Company salesmen do not sell radio. They sell entertainment.

A salesman is required to know something about radio and also to be able to talk in the proper vernacular to the dyed-in-the-wool radio enthusiast. More important, however, is the fact that he is urged to keep abreast of all important broadcasts. The Universal Radio Company is owned by the operators of radio station WCAU, situated on the top floor of the same building, and for this reason, perhaps, those at its head are keenly aware of the importance of broadcasting in promoting the sale of radio.

"Our salesmen talk entertainment," says Mr. Moore, "and they try to find what sort of entertainment particularly interests the prospect in question. Once this is discovered, they take advantage of it by referring to broadcasts of note along that line and by demonstrating programs of that kind whenever possible."

Every Universal salesman is carefully instructed to sell radio for just what it is—no more, no less. No claims that cannot be substantiated upon demonstration are made for sets. Prospects are led tactfully but surely to realize that no radio is perfect—but that a good radio in the home offers a mighty interesting box seat at the vast Theatre of the World. They are

(Concluded on page 124)

RADIO'S ADVERTISING BUDGET

\$25,000,000

DURING 1929, the radio industry spent \$25,000,000 for all forms of national advertising. This huge sum is only 3.8 per cent. of the probable sales for the same period. If 3,000,000 radio sets are sold in 1929 this means that \$8.35 will be spent by the industry to advertise each complete set, including tubes, loud speaker, cabinets, etc.

The information presented in table form on these two pages shows all available facts about national radio advertising expenditures. The second table on this page indicates how radio as an industry ranks in newspaper advertising expenditures with other leading businesses. Radio, it will be seen, ranks well up among the leaders. In newspaper advertising, forty set manufacturers filled 80 per cent. of the space bought by the radio industry. The six set manufacturers who bought newspaper lineage in large volume in 1928 are: Company A, 3,900,000 lines; Company B, 3,050,000 lines; Company C, 2,069,000 lines; Company D, 1,584,000 lines; Company E, 1,583,000 lines; Company F, 1,269,000. (Makers represented here include Crosley, Sparton, Majestic, Kolster, Atwater Kent, and RCA.) It is likely that the 1929 figures for newspaper lineage will show about the same relation, although total newspaper expenditures by radio advertisers in 1929 will show an increase of 29 per cent.

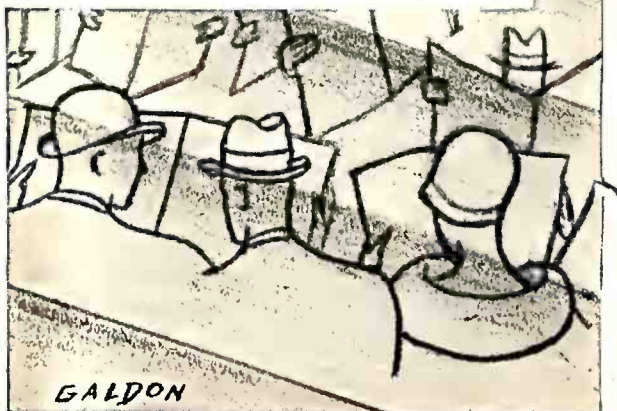

How Radio's Advertising Is Distributed

(National advertising expenditures in various media by radio industry)

	1928	Estimated 1929	Increase	% of total	
		(2)		1928	1929
Newspapers (1)	\$7,500,000	\$9,725,000	29%	41.7	39.0
Magazines (3)	2,500,000	3,400,000	36%	13.9	13.5
Trade Magazines (4)	1,250,000	2,000,000	60%	6.9	8.0
Broadcasting (5)	1,825,000	3,500,000	91.5%	10.1	14.0
Talent (6)	465,000	800,000	72%	2.6	3.2
Direct Mail and all other types (7)	4,460,000	5,575,000	29%	24.8	22.3
	\$18,000,000	\$25,000,000			

- 25,046,155 lines in 369 newspapers in 77 cities reported by Sales Management.
- Based on increases reported by Survey of Current Business.
- Publishers Information Bureau.
- Special report made for Radio Broadcast by P. I. B. Covers period from June 1928 to July 1929.
- Time charges on N. B. C. and Columbia—courtesy of Glen W. Foster, of Columbia Broadcasting Co.
- Estimated by Mr. Foster
- Estimated on basis of research conducted by Sales Management.

National Advertising in Newspapers

(Compiled by Media Records for Sales Management)

IN 369 NEWSPAPERS
(70 Cities)

Product	No.	Lineage	Total % of
Automotive	218	161,105,000	31.97
Groceries	498	77,880,789	15.43
Medical	456	64,572,697	12.81
Tobacco	91	41,088,460	8.16
Toilet Articles	232	38,355,088	7.61
Transportation	179	30,942,884	6.10
RADIO	104	25,001,999	4.96
Electric Appliances	71	12,711,191	2.52
All Other	736	52,408,153	10.44
Totals	2585	504,066,261	

IN 70 ROTO SECTIONS

Product	No.	Lineage	% of Totals
Automotive	26	1,694,756	17.80
Groceries	33	1,647,162	17.34
Medical	38	1,085,987	11.43
Tobacco	9	903,111	9.51
Toilet Articles	63	2,254,844	23.74
Transportation	17	71,829	.76
RADIO	4	44,156	.47
Electrical Appliances	12	395,138	4.16
All Other	92	1,397,025	14.79
Totals	294	9,494,008	14.79

How Trade Advertising Is Divided

Kind of Account	Number of Accounts	Cost of Space	Percentage of Cost
Radio Sets-Mfrs.	70	\$386,148	31.94
"-Jobbers	54	47,567	3.94
Loud Speakers	51	92,969	7.69
Furniture	59	74,074	6.13
Tubes	53	197,343	16.32
Parts	257	236,447	19.56
Sub Total	544	\$1,034,548	85.58
Photographic	82	118,906	9.83
Miscellaneous	75	55,482	4.59
Totals	701	\$1,208,936	100.00

Figures Showing How and Where Radio Manufacturers Have Spent Their Advertising Appropriation

By T. A. PHILLIPS

Manager, Research Division,
Doubleday, Doran & Co., Inc.

The industry is spending large sums in trade magazines as the table on this page shows. These figures, incidentally, are presented for the first time anywhere. The figures are based on actual count of the leading publications in a survey made by Publisher's Information Bureau especially for RADIO BROADCAST. It is worth noting that an increase of 60 per cent. in trade advertising is estimated for 1929. The supplementary table shows how this trade advertising is divided into various classes.

During 1929, radio companies have spent about \$3,500,000 for time over the two leading national networks and an additional \$800,000 for talent, according to an estimate of Glen W. Foster of Columbia. Total estimated expenditures for broadcasting throughout the United States by all advertisers for 1929 are estimated by Mr. Foster at \$60,000,000 for time and \$15,000,000 additional for talent. It is evident here that radio manufacturers are bearing their share of support of the broadcasting industry.

All the figures presented here, with the exception of advertising expenditure in trade publications, do not include advertising of musical instruments or phonographs and accessories for these two classes of merchandise.

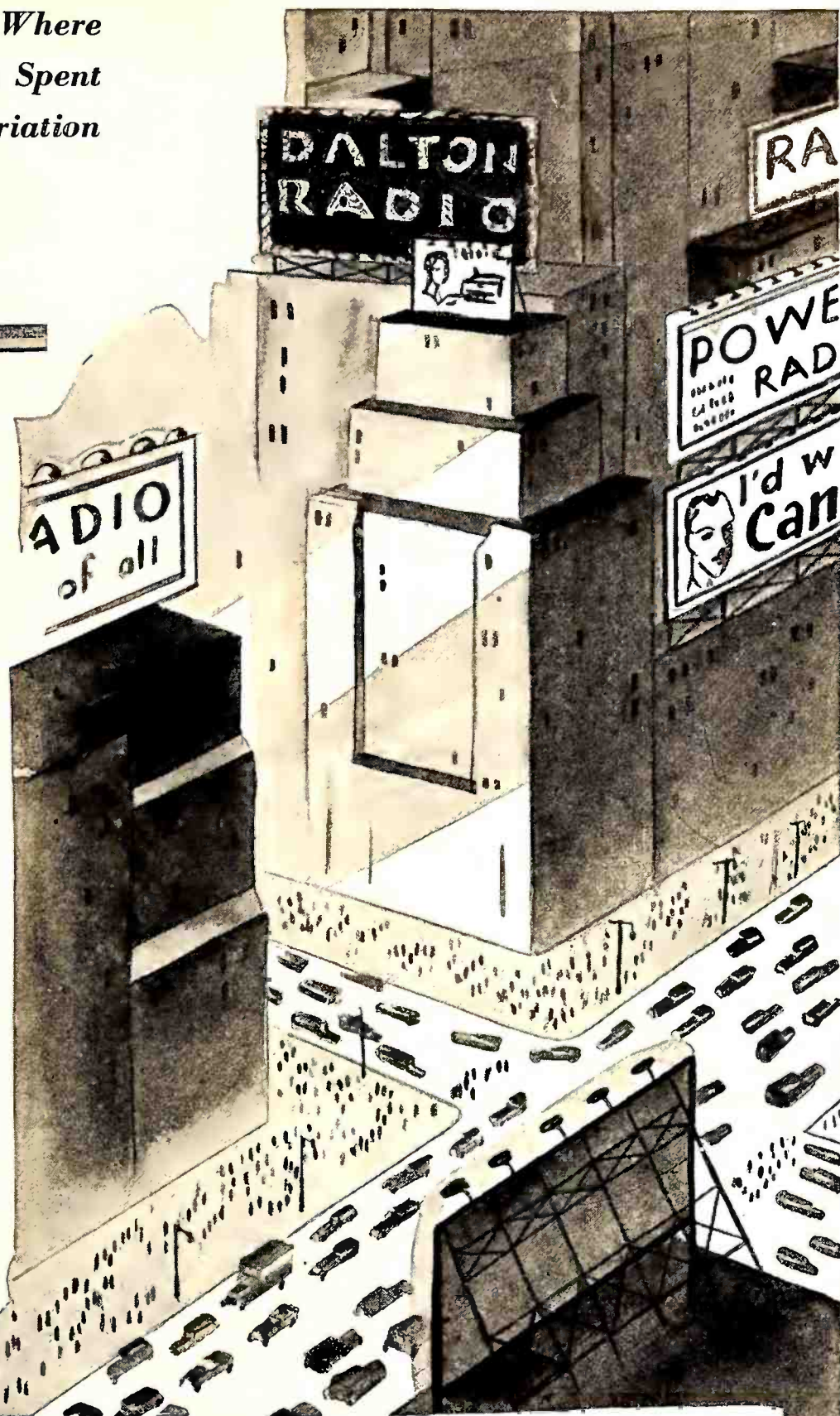

Radio Advertising Expenditures by Territories in Trade Media

TOTAL ADVERTISING EXPENDITURE ALL MAGAZINES
(By Territories and Classifications of Accounts)

Territories	Radio Receivers (Mfrs.)	Radio Receivers (Jobbers)	Loud Speakers	Radio Furn.	Tubes	Parts	Phono- graphic	Misc.	Total
N. Y. City	\$116,694	\$10,004	\$22,388	\$17,808	\$79,641	\$62,247	\$74,418	\$33,858	\$417,058
N. Y. State	18,927	220	4,438	404	—	6,362	—	525	30,876
N. England	4,174	99	2,455	1,392	46,285	27,722	3,342	4,338	89,807
Pa. & South	70,167	8,713	12,422	13,702	42,872	29,154	4,422	6,077	187,529
Chicago	111,184	22,592	44,492	17,785	22,581	56,378	12,351	9,255	296,618
Michigan	35,971	5,342	807	7,763	—	17,972	455	93	68,403
Ohio	10,917	297	—	285	1,053	13,524	1,360	171	27,607
Mid West	17,732	300	5,880	14,935	4,911	21,574	21,134	1,165	87,631
Far West	382	—	87	—	—	1,514	—	—	1,983
Foreign	—	—	—	—	—	—	1,424	—	1,424
	\$386,148	\$47,567	\$92,969	\$74,074	\$197,343	\$236,447	\$118,906	\$55,482	\$1,208,936

WHAT IS THE SIZE OF YOUR SLICE?



By **HOWARD W. DICKINSON**

Merchandising Consultant

SPEND MONEY in advertising. Use the power of that advertising to maintain prices. By taking full profit per sale make the business pay.

Why is it that so many dealers recognize the force of these three commands and yet fail to get their full price for either merchandise or service?

Is any one thing in retail selling more important than to find out why this difference exists between right and provable theory on the one hand and common dealer's practice on the other?

Every dealer wants full price and full profit. By all sound laws of commerce he should have them. What prevents his taking them? *Should* those things prevent the dealer from taking them? What remedy has he in his own hands to cure the situation?

There are no more important questions than these among all the complications of buying and selling for a profit. We accept sound theory as theory, then, in practice, we go out and give away the shirts off our backs because someone else seems to be doing so.

Lopping off a legitimate price is easy. Doing a sweet and convincing job of advertising is harder. Is that the reason?

Let us consider some of the price and profit conditions which every retailer in radio is up against.

The Dealer's Problem

Here is what they face, dealer's discount about 40 per cent.—overhead, sales cost, and so on from 30 to 35 per cent. and rarely less. It takes an exceptional financier to reduce costs below that and maintain a business which gives the impression of self respect and wholesome prosperity.

Let us figure on an average 8 per cent. profit—the man who beats that and also makes his business grow, does very well indeed. The man who gives away materials, does wiring free, carries heavy unpaid customer balances without interest charge, gives away more than a sound business man can afford to. He is pretty sure to run way below 8 per cent. profit on his turnover unless he starves his advertising and sales work and charges up his extra service against his advertising account.

It is a costly habit to charge against advertising any

item which *might* help build good will, because in this way many a man has had a heavy account charged to "advertising" without having had any advertising.

The good will to be obtained by gifts of expensive service and disproportionate allowances can be overestimated very easily. It may have some value—but a customer once sold can be profitable again only as he wants parts, repairs, and ultimately perhaps a new set, and if he has received more free than his due he is apt to be a "spoiled" customer.

Sooner or later an intelligent dealer must learn the relative values to himself of straight advertising and so-called advertising by generous concessions. He must learn which kind of customers pay him best, the "gimme" type of people or the people who pay for what they get and expect others to pay them for what they in turn give or do.

Do the majority of people want "gimme" service or straight businesslike service?

Is "gimme" service demoralizing to the business which advertises by gifts instead of with advertisements?

Are sales which cost more than their gross returns the kind of sales which make it interesting to do business?

Can the dealer who begrudges money spent in straight advertising build the business to success by letting his customers pull his leg with respect to the high-priced time of his expensive service force?

Does it seem foolish to ask these questions? By no means, so long as many dealers are kidding themselves into losses instead of profits and unintentionally demoralizing the market for those dealers who are trying to do business in a businesslike way.

Sooner or later we've got to come to a serious consideration of finance, either to be able to count our profits or to figure out what we've got left for our creditors.

Let us imagine this financial situation. A dealer has just sold \$2000 worth of sets on installments. He has a book profit of \$800 on these, but only \$500 cash because he has disposed of them on a 25 per cent. down basis and is carrying \$1500 on deferred payments. He can hardly carry that for less than 8 per cent. allowing for interest collections, defaulted payments, deterioration on good returns, etc.

If these payments run over a year's period, he must deduct

GET YOUR SHARE

Charge Full Price for Merchandise, Financing, and Service. Be Careful When Charging Good-Will Gifts to Advertising. Make Your Newspaper Advertising Pick the Right Kind of Customers—Avoid the “Gimme” Type.



\$120 at least for “carrying” from the \$1500 that he must get back. So instead of \$2000 he gets only \$1880.

So here we are—

Sales	\$2000
less 32%	640 (general cost of maintaining business)
	<hr/>
	\$1360
less	120 (deferred payment cost to dealer)
	<hr/>
	\$1240
less	1200 (actual cost of \$2000 in mdse at 40% off.)
	<hr/>
	\$40 profit to dealer

which is 2% of a \$2000 turn over.

Sales	\$2000
less 32%	640 (general cost of doing business)
	<hr/>
plus	\$1360
	150 (10% charge for financing \$1500)
	<hr/>
	\$1510
less	120 (8% cost of financing etc.)
	<hr/>
	\$1390 net
less	1200 (actual cost at 40% off)
	<hr/>
	\$190 actual profit to dealer

which is 9.5 per cent. of \$2000, and is 4 $\frac{3}{4}$ times as much profit as \$40 or 2 per cent.

Not enough profit. His stingiest “gimme” customer will admit that it is not enough profit. If installments stretch out for a year it means 2 per cent. per annum.

(Note. If the business were on a cash basis and there were 12 turnovers per year at 2 per cent. each it would make an annual profit of 24 per cent. which would be quite interesting.)

Suppose now our dealer realized that it was costing him 8 per cent. or more to carry deferred payments and he added a 10 per cent. financing charge for safety and profit on this financing. (That is done in many lines)

Then we should have these figures.

PICK YOUR CUSTOMERS



It makes no difference whether these figures are accurate or average or what. There is some such financing problem in connection with any charge account or deferred payment business, and those business men who recognize this fact and act accordingly are the ones who are going ahead the fastest.

Many people think that concessions, free service, and so on are profitable advertising but it is seldom that they are. They are mostly sucker bait where the man who baits the hook is the sucker himself.

Contrast this expensive habit with the habit of advertising well, keeping your name and your offerings before the people in your town, presenting the dignity of a business which puts its best foot forward in public prints, and giving the impression of a straight, profitable, up-to-date demonstration of articles which are obviously worth their price.

Let us say our 30 to 35 per cent. overhead carries some advertising cost. If the “gimme” idea is in the merchant’s mind he will advertise his *concessions* more than his *goods*. That will bring more “gimme” customers and still more carrying costs, free service, and risks of default and returned merchandise. In that way he may be advertising to increase his losses, spending money to help himself lose money.

If newspaper advertising is businesslike, featuring the goods, the quality of the shop, and the high-grade character of standardized service at standard prices, it should bring the better class of customers, the kind that recognize their responsibility for paying legitimate bills, customers who, if they need financing will see the reasonableness of paying for it. If a decent man doesn’t see it in that light he can be made to as experience in many lines has shown.

Here is the great trouble. It is a psychological rather than logical trouble. The straight-line dealer is apt to over-estimate the yearning of the public for “bargains.” Bargain hunting is a sport with a considerable following, of course, but advertising has created a bigger following for the sport of learning about interesting goods and paying the price for them.

THE JOBBER'S



NEW PLACE

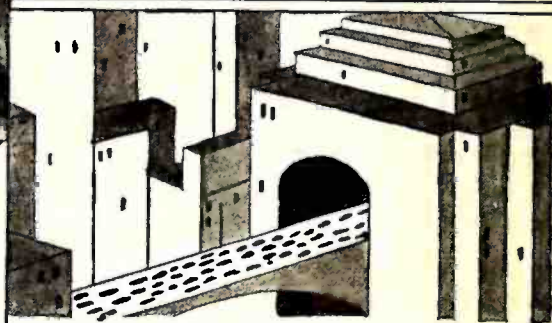

A Reprint from *Printer's Ink*

By **A. H. DEUTE**

General Manager, *Billings and Spencer*

A FEW MONTHS AGO, just as a new man was about to tackle the sales problems of the Glastonbury Knitting Company, I said to him: "What are you going to do about the jobbing situation? I understand that the Glastonbury line has been marketed entirely through jobbers."

Stanley Klein was this newcomer in the knit-goods industry, and he said to me frankly: "I haven't any idea. The off-hand impression is that the jobber is a thing of the past, especially in the knit-goods and dry-goods industries. So, off-hand, one might say that we'll look elsewhere for our distribution."

"However, I'm not going to scrap anything on hearsay. First, I'm going on the road and have a look."

He has returned from his trip and the first thing he said to me was: "I'm for our jobbers 100 per cent! I'm not for them 100 per cent. as they are working just at this moment, but I honestly believe that enough jobbers see the way in which they must be going to make it well worth while for the manufacturer who has been allied with them thus far to continue in his course."

Klein, who had made an outstanding success in the hardware and kindred industries, went into the knit-goods industry without prejudice, and his viewpoint develops an interesting angle.

It is this: Old-school jobbers, like many old-school retailers, were so deeply rooted in their theories and prejudices that it has taken several years of severe jolting to shake them loose from these beliefs. This jolting process has been so severe that it has proved fatal to an untold number of retailers and to a great many jobbers. But while it has proved fatal to many there is no evidence, so Klein believes, and I agree, that the jobber is to be a thing of the past, any more than that the individual retailer is apt to become a thing of the past.

On the other hand, there is much evidence to prove that the individual retailer and the jobber who serves him must both change their ideas, theories, and methods—change them radically and quickly. In other words, both of these groups must drop out or change to conform with the newer conception of merchandising. Neither can remain where and as he once was.

In what way must the jobber change so radically?

The answer is this: The jobber must change from a buyer at heart to a seller at heart.

Talk to the average head of a jobbing house. Look over his organization. The outstanding point of interest is that you will see not one or two buyers, but a group of them—possibly a dozen or more. Over against that group of a dozen or more buyers, you will probably not find a single competent sales manager. Personally, I can count on my fingers, and not have any need for thumbs, the men connected with wholesale houses who honestly consider themselves *real* sales managers. The great majority who have the title of sales manager will admit that they are either desk order clerks or that their main job is to get out the order sheets which the buyers prepare and check over the salesmen's expense slips. Others will tell you that their principal work is to go over the salesmen's orders and either price the items or approve the prices the salesmen have set. And woe betide the individual who undertakes to argue prices with the salesmen.

There you have the set up of nine jobbing houses out of



IN MERCHANDISING

Looking to 1935 the Jobber Will Change at Heart From a Buyer to a Seller, and This Change Is Being Reflected in the Changes Made by Up-to-Date Retailers, too. A New Highly Efficient Merchandising Set-Up Will Be Established

ten. On the one hand you have a group of buyers whose job it is to buy as cheaply as possible.

On the other, you have a group of men on the territory, who, all too frequently, run their territories as they choose and make prices as they choose, subject only to certain set minimums. Each man sells what he feels like pushing. As one of these so-called sales managers said recently, rather bitterly: "If we'd only realize it, all of us on the inside are just menials doing detail work for the salesmen."

I have met hundreds of jobbers in various lines, but I cannot recall a single one who is taking as much personal interest in the business of selling as he does in buying. As I recall them each man stands out first of all as a buyer.

The head of the house talks and thinks "buying right." But when he thinks of "buying right," he isn't putting his buying thought in tune with selling.

There is a reason for that. Over a period of years, the manufacturer has become more and more the brand builder. The jobber has become the man who hands out what the dealer has call for. He has looked upon himself less and less as a brand builder. His primary thought has been to get demandable merchandise and get it at a minimum price. It has become a deep-rooted habit. Many of the present-day jobbers have had no opportunity to think along other lines. As jobbers they are first of all buyers—and good, close buyers—and they have trained their young men in this way.

And the individual retailer, who has learned what he knows about merchandising largely from the jobber, has followed in the same channel.

The Chain Store Enters

Now we have the chain stores. It does not require much study to convince one that the great difference between the chain store and the jobber-retailer lies in the fact that the former is not only an expert buying organization but *particularly* an expert selling organization.

This, in brief, is the result of the study which Klein made in a general tour of the country. But his study demonstrated one more fact—there are enough jobbers who have come to realize that they must make selling a fifty-fifty partner in their business to make it seem worth while for the manufacturer to give them a chance.

What the future of the jobbing industry is apt to be and what the future of the jobber as we have known him is going to be are now quite well defined. He has taken a definite position in the industry of distributing and even the casual observer can detect this position with accuracy. There is no longer any more guess work.



The jobbing industry will continue, it will continue as a definite factor, and it will soon commence to do a larger percentage of the gross business than it is now doing. I feel that one is safe in saying that jobbing, as a business, is now at the lowest ebb in which it will find itself in the present-day merchandising cycle.

The old-school jobber is winding up rapidly and definitely. And it is not so much the chain-store method of distribution that is winding him up but rather the new school of jobber.

The old-school jobber—the jobber as we have known him during the last twenty-five years, ever since, in fact, he ceased to be a brand builder—that type of jobber who put his mind upon buying and made buying his fetish with selling just a mere detail—is giving way rapidly.

Taking his place is the new school of jobber who is as much concerned with the selling end of his business as he is with buying. This new jobber is already with us. It is not his own selling which concerns him so much as it is the proper merchandising of his lines so that his retail outlets can in turn sell what they buy.

A Sales Lesson From A Golfer

One of the really good golfers in the country told me once that he always plays over in bed, the night before, the match which he is scheduled to play the next day. Before retiring for the night before his match, he walks slowly and thoughtfully over the course, getting a mental picture of each hole. Then in bed that night he works out his game. The next day he plays it that way, regardless of what his opponent is doing.

It might be equally sound for many a sales manager to plan his selling five years from now in the same way. So, just as the golfer looks over his course in advance, let's look over the jobbing situation in 1935. Let us take the present trends and indications and extend the line ahead five years.

Here is the jobber of 1935!

The most advanced jobbers are going to be the drug jobbers. The next most advanced group will be the grocery jobbers. Then will come the hardware jobbers. And then the dry goods jobbers. There will be outstanding jobbers who will stand out in front of their groups, but as groups the foregoing seems reasonable, based on where they stand at present. And their present position is due to the pressure which chain stores have thus far brought to bear.

In 1935 the old-style jobber sales force will be quite thoroughly out of the picture. That is going to be so because retailers will not have to be talked into what to order.

The great mass of worth-while dealers will be grouped with one jobber or another. The jobber will have closely knit working arrangements with a given number of retailers—based on an economical minimum. But whether there be 250 or 500 or more retailers aligned with a given jobber, those retailers will work as a group—as a body.

As nearly as practical, the retailers will be
(Concluded on page 122)

TESTED SALES IDEAS

Dealer Directs Field Crew from Truck

THE FOLLOWING is an outline of a plan, now in use by a Bosch dealer in one of the largest cities in the country, which is netting more than 20 set sales a week:

1. Operates from truck stocked with various types of consoles and table models. Parks truck in central location from which men radiate to make house-to-house calls.
2. Uses four men in addition to sales manager who travel with the truck.
3. Pays men 10 per cent. commission on "cold" sales, 5 per cent. on "store-lead" follow-ups.
4. Men seek demonstrations, not sales, and find that time should not be wasted on totally disinterested people.
5. Within a few minutes of the time the permission is secured, the truck delivers the radio set and the sale is started.
6. Three days later the truck calls and either the sale is consummated or the set removed.
7. Terms are not less than 20 per cent. down, and 10 months in which to pay the balance.
8. The sales manager is always within "a stone's throw" for decisions on all matters beyond the authority of the salesmen. Trade-in and credit matters are quickly settled. He is near at hand for reinforcement when necessary. His availability serves to encourage the men.

Inexpensive Publicity That Counts

MR. SPECKER, of the G. & S. Sales Corporation, East Chicago, Ind., believes in getting Kellogg sets before the public eye by displaying them at public places. He learned that St. Mary's Church in his city was to have a bazaar early in May, so he decided that he wanted to sell a Kellogg receiver to the church to be raffled off during the bazaar, not only for the profit but also for the fine publicity that would result. Mr. Specker convinced the church committee that it would be to their advantage to place the set on display three months in advance of the bazaar so as to get people talking about it and arouse greater interest.

What Happens When Dealers Coöperate

SEVEN RADIOLA dealers in Richmond, Virginia—seven keen merchants—seven keen managers—coöperate with each other by meeting once every month to discuss happenings of the preceding month and analyze conditions. The seven men are free-traders in ideas. One of these dealers was once asked, "Why are you willing to divulge your selling ideas to these six competitors of yours?" The answer was, "Because I am sure that these men know as much about selling Radiolas as I do. They have been in business a long time; some of them as long as I have, others much longer. Every time that

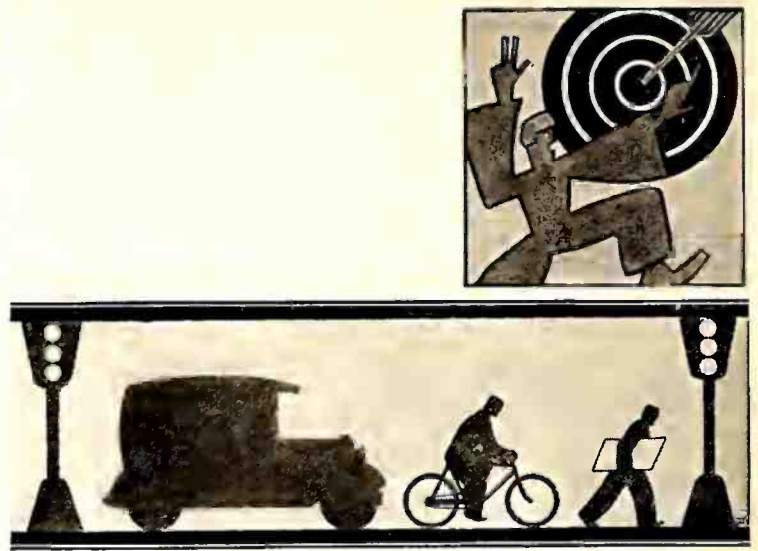

Each Month These Pages Serve as Our Clearing House For Merchandising Ideas of Proved Value. Every Radio Dealer Should Read Them Carefully

I go to one of our meetings with a good progressive sales idea, I am pretty sure to come home with five or six additional ones that are just as good as mine." Whenever a new set is introduced by RCA these dealers advertise coöperatively in local newspapers to make a perfect tie-in with the regular RCA advertisement. These seven dealers know their market; and experience has taught them what to do and when to do it. At regular intervals these dealers sponsor and pay for excellent programs over one of their local stations. These seven dealers are: Johnson & Morris, C. A. Baylor Company, Rountree Corporation, Whitten Brothers, Edgar M. Andrews, The Corley Company, and Petit & Company.

Making Money Out of Trade-ins

How to realize a profit on sets taken in trade is a problem to every dealer. Some dealers are satisfied to close them out for what they can get while others feel that they must realize as much as, or more than, was allowed. One of the ways to get your money out of these sets is to use them for renting.

Your local hospital is full of good renting prospects. Arrange with the superintendent to furnish receivers on request to





patients. There are always a number of convalescents who would enjoy radio entertainment. You will find you can do a lot of business at \$1.50 a day per set. Your trade-in sets working for you at this rate will soon pay for themselves.

Try This Stunt In Your City

THE GARDNER RADIO SALES, Kendallville, Ind., dealer in Bosch screen-grid radio, recently sponsored a novel publicity stunt which aroused much interest there.

When the circus came to town a few weeks ago, officials of the firm obtained the use of a large elephant (not a white one). The Gardner Radio Sales featured Bosch screen-grid radio on a banner which was placed around the pachyderm and thus paraded through the city streets.

Sell a Set to Your Doctor

SELL A SET to every professional man or woman in your community. Have you ever wondered, as you sat and waited in the reception rooms of your attorney, your physician, or your dentist, why time hung so heavily on your hands? Think of the times you have sat and twiddled your thumbs while you shifted your eyes from the floor to the wall and then to the faces of other "clients" or "patients."

Here's the idea. Sell a receiver for use in these reception rooms. Show how it will keep clients and patients in a cheerful mood. In many cases the idea will appeal and you have created a new outlet for business. We suggest that you offer to make a trial installation in your doctor's reception room to-day.

Making Outside Salesmen Pay

IHAVE SELECTED a line of merchandise—Atwater Kent—that is nationally advertised. There is less sales resistance to it, and I'm not obliged to spend half of my selling time in trying to convince customers that it is just as good as some other radio.

I am not afraid of using newspaper space because I believe the newspaper is better than many other forms of advertising. I run good-sized copy twice every week during the heavy part of the season and my ads bring results.

If I can't sell a customer in the store, I always get his name and give it over to an outside salesman.

I have two high-class salesmen who follow store leads. These men have a regular territory and keep an accurate card record on their calls. Sometimes a card will have 15 notations before the sale. Persistency!

I know my outside salesmen are responsible for two thirds



\$5.00 FOR YOUR PET SALES IDEA

These pages are a regular feature of *Radio Broadcast* where we present ideas, both big and little, which are of proved service to dealers. If you have a pet sales idea, a stunt that produced results for you, tell us about it. *Radio Broadcast* will pay \$5 for each contribution used. A letter will describe the idea, a rough pencil sketch or photograph will help illustrate it and we shall do the rest. If you have a pet sales idea, send it in. Address Merchandising Editor, *Radio Broadcast*, Garden City, New York.

of my business and I pay them an attractive commission. Good salesmen earn good money with me.

—WESLEY F. EWINGER, John Ewinger Company, Burlington, Iowa.

Increasing Service Efficiency

WHENEVER WE go on a service or repair call we make it a point to suggest to the owner the purchase of various accessories that may be advantageously employed with his receiver. We also point out that we will gladly demonstrate any accessories without cost.

As our minimum service charge is \$2, and as the average service call takes no longer than about fifteen minutes we find that it pays us to have the serviceman spend the balance of the hour that is fully paid for by the service fee in an attempt to sell the customer whatever accessories he or she can use to good advantage.

In this manner even if we do not make a sale we have the customer himself pay for the time spent for demonstration purposes; this eliminates unpaid for time and fifty per cent. of all attempts result in sales of accessories.

—BORIS S. NAIMARK, The Riverside Auto Supply & Radio Company, New York, N. Y.



HOW ABOUT TIME PAYMENTS?

Not many weeks ago RADIO BROADCAST sent out a questionnaire to 500 radio dealers. These dealers were chosen at random but with sufficient care to insure that they represented all types of outlets handling radio. It should be understood that no effort was made to secure answers from a majority of the 38,000 radio outlets in the United States, and that the replies tabulated on these pages are not offered as conclusive or final. However, we considered the results of interest and asked Howard W. Dickinson, a nationally known merchandising consultant, to analyze and comment on the survey. He says:

TO ME THE questionnaire recently sent out by RADIO BROADCAST to 500 radio dealers has brought forth very interesting results. They are "Straws which show how the wind blows," if you will. These straws indicate quite a variable wind with reference to trade practices.

The value of an investigation of this type lies not so much in the determination of facts as in the chance it gives each dealer to ask himself, "Should I do this, or that, and Why." So, Mr. Dealer, please do not look for the statement of positive laws of action and do not be surprised if this comment on the questionnaire resolves itself into some more questions which are for you to answer.

How Sales Are Financed

The first question in the letter sent out by RADIO BROADCAST asked: "How do you finance time payments? Carry them yourself, or through a finance corporation or banker?" Dealers answered this question in three different ways: (a) 32 per cent. finance their own sales; (b) 43 per cent. finance through a bank or finance corporation; and (c) 25 per cent. do it both ways.

Shall we conclude from the above that the (a) and (c) groups are more heavily financed for each unit of turn-over than group (b)? Could it mean that the (b) group has established better credit for securing the help of outside capital than the (a) group? Or, does it mean that the (a) group adds somewhat to its book profit by saving the cost of securing outside capital? This latter might easily be an expensive saving, if it ties up the capital which should go into advertising.



It is interesting to see that more than two thirds of those who reported on this question get some outside capital to help in financing time payments—evidently this is the predominant trade habit. Shouldn't almost everybody do it, particularly the great majority, who give themselves less promotion than their business needs?

I got quite a shock from the answers to the next question—"Are you insured against defaults in time payments?" Only 8.5 per cent. of the dealers answered "Yes" and 91.5 per cent. answered "No"!

Insurance is relatively cheap. Chattel mortgages are not expensive, and I am inclined to believe that only a man with a lot of money can afford to carry his own insurance himself. Do the answers to this question indicate a deplorable lack of financial self-protection in the radio business? Is it not true that whenever general business conditions grow worse for a time, credit risks on installments show an even greater tendency to increase? Possibly different dealers interpreted the word "insurance" differently.

Interest Charged

Now comes the question which intrigued me greatly as it was bound to show a variation of considerable range—"What interest do you add to price?"

One dealer out of every fourteen—7 per cent.—does not charge interest to cover time-payment financing. I wonder why. It has become a pretty common practice and an obviously reasonable one in all kinds of installment selling.

Let us see what the rest of the dealers charge for financing: 2.8 per cent. ask 5 per cent. interest (This is generally less than cost); 14 per cent. charge 6 per cent. interest—obviously an attempt to split even on this item; 15.2 per cent. get 7 per cent. interest; 19.3 per cent. charge 8 per cent. interest; 5.4 per cent. ask for 9 per cent. interest; and 16.6 per cent.—one sixth of the dealers—charge 10 per cent. interest. In addition a few dealers—2.8 per cent.—charge 12 per cent. interest and 14 per cent. of the dealers charge 1 per cent. interest per month. Another plan which is followed by a few dealers—2.8 per cent.—is to charge \$1.00 per month, which might be a low rate or a high rate according to the volume of the sale.

These answers show that there is ample precedent for making deferred payments return an interest charge, and it is perfectly proper that they should. Isn't 10 per cent. a very reasonable and proper charge to make for financing?

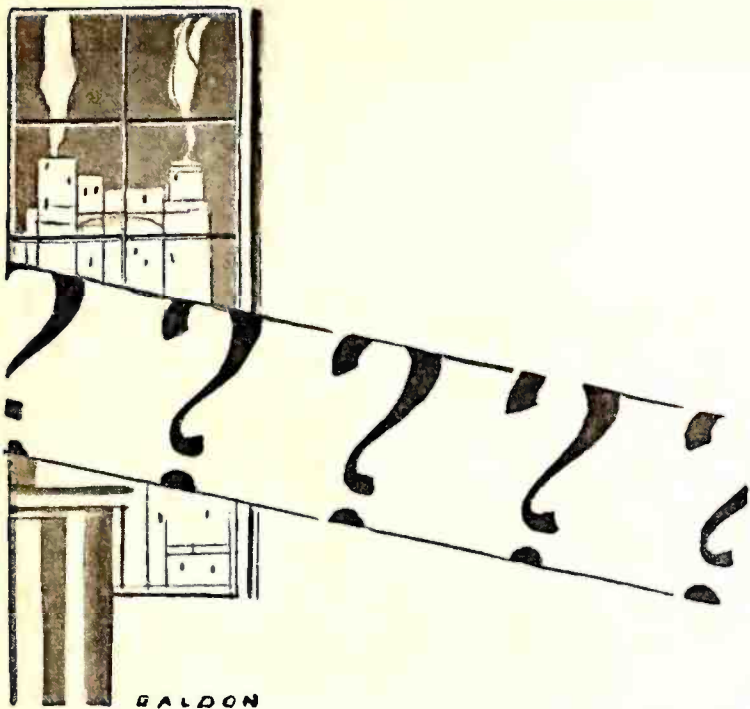

The answers to the next question—"Do you charge a uniform down payment?"—show that a majority of the dealers want to know what it means in cash to make an installment sale: 71 per cent. answered "Yes" and 29 per cent. said "No."

Isn't there a supersensitiveness to what the customer thinks he wants in those "No" answers? Shouldn't the customer recognize the dealer's need of exact methods in this particular? I believe that he can easily be made to, and the 71 per cent. seem to have put that belief into practice.

Down Payment Required

Here we come to another wide variation. I confess it surprises me to learn that as many as 48 per cent. of these dealers get one fourth of the price or better as a down payment. Obviously, it can be done. Isn't it also obvious that it should be done?

Here is the tabulation: 12 per cent. of dealers say 10 per cent. down. 12 per cent. say 15 per cent. down. 27 per cent. say 20 per cent. down, 23 per cent. say 25 per cent. down, and 16 per cent. say 33 per cent. down. So we see that 68 per cent. get one fifth down or better.

What we get and what we want are often different. The next question is: "Do you want higher down payments?" To this 68 per cent. answer "Yes" and 32 per cent. answer "No." Does not the preceding tabulation indicate that those who want larger down payments can get them? Obviously others have.

Queer how the percentages in the next question—"Do customers want lower down payments?"—almost reverse those in the last. In replying to this 61 per cent. answer "Yes" and 39 per cent. answer "No." Obviously, again, customers do not want lower down payments badly enough to prevent their buying sets.

Percentage of Cash Sales

The need for insuring against defaults in installment payment and for collecting sufficient interest is shown in the answers to the question, "What proportion of your sales are cash?" About half report that 10 per cent. or less of their sales are for cash. Obviously it takes a fairly good financier to be in the radio business if half do business with only 10 per cent. or less of cash sales.

Here is the story: 21 per cent. report cash sales of 2 to 5
(Concluded on page 122)

(1) FINANCING

(A) How Dealers Finance Time-Payment Sales.

- (1) Store finances sale—32 per cent.
- (2) Through finance company or bank—43 per cent.
- (3) Partly through bank or finance company and their own store—25 per cent.

(2) DOWN PAYMENTS

(A) Is Uniform Down Payment Required?

- (1) Dealers requiring uniform down payment—71 per cent.
- (2) Dealers not requiring uniform down payment—29 per cent.

(B) How Large a Down Payment Is Required?

(1) Per Cent. of Sale Required as Down Payment	Dealers Reporting
10	12.0%
15	12.0%
20	27.0%
25	23.0%
33	16.0%

(C) Do Dealers Want Higher Down Payments?

- (1) Dealers answering yes—68 per cent.
- (2) Dealers answering no—32 per cent.

(D) Do Customers Want Lower Down Payments?

- (1) Dealers answering yes—61 per cent.
- (2) Dealers answering no—39 per cent.

(3) INTEREST CHARGES

(A) What Interest Charges Are Asked?

(1) Interest Charge	Dealers Reporting
None	7.0%
5%	2.8%
6%	14.0%
7%	15.2%
8%	19.3%
9%	5.4%
10%	16.6%
12%	2.8%
1% per month	14.0%
\$1 per month	2.8%

(4) BAD DEBTS

(A) What Proportion of Sales Are Bad Debts?

(1) Per Cent. of Bad Debts	Dealers Reporting
None	29.0%
1 or less	38.0%
2	13.0%
3	6.5%
5	11.0%
10	2.5%

(B) Are Dealers Insured Against Defaults?

- (1) Dealers carrying insurance—8.5 per cent.
- (2) Dealers not carrying insurance—91.5 per cent.

(C) How Are Dealers Insured Against Defaults?

- (1) Commercial credit company—1.4 per cent.
- (2) Lease—1.4 per cent.
- (3) Chattel mortgage—2.8 per cent.
- (4) Insurance policy—1.4 per cent.
- (5) Mortgage—1.4 per cent.

(5) CASH SALES

(A) What Proportion of Set Sales Are Cash?

Per Cent. of Cash Sales	Dealers Reporting
2 to 5	21.0%
5 to 10	38.0%
10 to 20	16.0%
20 to 30	8.5%
30 to 50	11.0%
80 and over	4.0%

(B) Are Cash Sales Larger Than Last Year?

- (1) Dealers answering yes—30 per cent.
- (2) Dealers answering no—70 per cent.



PROFESSIONALLY



SPEAKING

REGARDING STYLE CHANGES

THERE ARE PEOPLE who never cease comparing the radio industry with the automotive industry, the phonograph industry, or some other industry which has had its days of youth, adolescence, and maturity. In general we decry such comparisons, but in particular we must admit there are certain similarities.

Automobiles are sold to-day on two legitimate appeals, that of style, and that of technical advance. It is difficult to estimate how many of the style changes in the automotive industry are dependent upon technical advance, but it is certain that they were not made possible by engineering changes to the extent that they are in radio. It is necessary only to think over the style changes in radio to estimate how many were dependent upon radio engineers and not style engineers. Single dial sets, consoles with radio, loud speaker and power supply in one cabinet, freedom from a multiplicity of knobs and accessories brought about by the development of automatic volume control, disappearance of regenerative sets, invention of uniform gain circuits, production of a.c. tubes, change of panel effect by automatic tuning or remote control, and development of drum dials—all have been made possible by technical advance.

It seems probable that the future will find radios sold as much on style change as on technical advance. It seems advisable, then, to divorce style engineering from circuit design, and to remove from the hard-working radio engineer one of the worries that lingers in the back of his head.

A RADIO FOR THE FARMER

AFTER NEGLECTING the farm market for several years—although everyone admits the rural dweller has the most to benefit from radio—it appears that the farmer is to be subjected to the selling pressure of many if not most of the receiver manufacturers now competing for the a.c. business.

It is to be hoped that the sets made purely for the listener unable to enjoy the privilege of drawing power from house wires will not only operate from batteries and pull-in the desired stations but that they will also be inexpensive in first cost and economical in maintenance. Those not blessed with power circuits can now enjoy radio by means of battery-operated receivers and have been able to do so for a number of years. What they cannot enjoy is lugging the battery to town to be charged, and the continual drain on B batteries. They do not want just another battery set; they want a set that is engineered with their particular problem in mind, a set that operates for a month from a single battery charge and which

consumes only one set of B batteries a year instead of two or three.

A set for the rural dweller should have about four tubes, probably three screen-grid tubes and a power tube. These screen-grid tubes should have better filaments than those now obtainable. They should last longer and be less microphonic. The power tube should be similar to the pentodes now being used extensively on the Continent. They are more efficient than any American power tube, both from the standpoint of the amplification necessary to produce a given amount of power output, and from the standpoint of battery power

consumption. In other words, they make possible a set which costs less to maintain as well as less in first cost.

At present it is possible to buy a radio set for less than \$60, which is probably near the rock-bottom price with present methods of distribution. There is little to be hoped for in the direction of lower first cost, apparently.

One tube manufacturer (De Forest) has announced a d.c. screen-grid tube that is sturdier than those ordinarily obtainable. It has an oxide-coated filament and heavier construction. Of eight tube manufacturers interviewed at the New York Radio Show, only one had heard of pentode tubes and the majority of the others were disinterested. Apparently there are more pressing problems in the average tube plant than developing new tubes. Or is it true that most tube manufacturers are still willing to let someone else pay the development cost?

FOREIGN VIEWS ON ADVERTISING

WIRELESS WORLD, an English radio publication, reports a decision of the Spanish government relative to radio advertising. Broadcast advertisements are stated to have killed enthusiasm for wireless and the State decree has stipulated that not over one hundred words of advertising per hour can be put on the air from a given station. This would be a severe handicap to some announcers and some advertisers in the United States. Some of the advertisements sound like a weather report transmitted at ten words per minute for North and South Polar regions and all intervening territories.

Another English paper laments the fact that radio programs in England, under the control of the B.B.C., a monopoly doled out by the government, do not compare with those of other nations where someone besides the listeners pay the bills. Particularly envious glances are directed toward the United States where the best musical and other talent is on the air through the sponsorship of national advertisers. It might be worth while to send to England those who orate most enthusiastically against our present broadcasting structure.

 *Please Note—*

What will sell radios in the future?

Let's divorce style engineering from radio circuit design.

The farmer—a new factor in selling radio.

How the Spanish government controls broadcast advertising.

CREW MANAGERS COMMISSION RECORD										
DEALER		CREW MANAGER						WEEK ENDING		
DATE	NAME AND ADDRESS	MAKE	MODEL	SERIAL No.	SALESMAN	AMT.-SALE	ALLOWANCE	NET SALE	COMMISSION	MISCELLANEOUS INFORMATION
DAILY REPORT OF NEW INSTALLATIONS										
DEALER		CREW MANAGER						DATE		
NAME AND ADDRESS	MAKE	MODEL	SERIAL No.	SALESMAN	AMT.-SALE	INSPECTOR	MISCELLANEOUS INFORMATION			
DAILY REPORT OF RETURNS										
DEALER		CREW MANAGER						DATE		
NAME AND ADDRESS	MAKE	MODEL	SERIAL	AMT.-SALE	REASON FOR RETURNING					
DAILY REPORT OF UNCLOSED BUSINESS										
DEALER		CREW MANAGER						DATE		
NAME AND ADDRESS	MAKE	MODEL	AMT.-SALE	ALLOWANCE	NET SALE	MISCELLANEOUS INFORMATION				

House to House Selling Is NOT a Sideline

By BAYARD B. PENROSE

HOUSE-TO-HOUSE selling, in the opinion of R. B. Green, radio sales manager for Parks & Hull, Inc., wholesalers of Baltimore, Maryland, should be done right or it had better not be done at all. In other words, if you do not have the time and inclination to take it in all seriousness and devote real thought and effort to selecting and training men, the profit side of your ledger will probably show a heavier balance if you do not bother with it. Properly handled, the door-to-door man can be made a valuable adjunct to the business. Considered merely as a sideline, he may become a decided detriment.

Mr. Green's Experiments

A survey of radio conditions in Baltimore would indicate that as many and perhaps more sets are sold here per capita by house-to-house methods than in any other city. Much of this activity has been inspired by Mr. Green who has helped dealers to use his home city as something of a "proving ground" for his ideas along this line. That they have proved successful is evinced by the success of individual dealers who have followed suggestions emanating from his office.

There are a lot of things for the average dealer to learn about this method of selling. He cannot hope to make a success of it merely by hiring men haphazardly and turning them loose on the assumption that it is costing him nothing until they actually produce sales. This has been tried frequently with inevitable failure as the result.

"A lot of dealers," says Mr. Green, "have literally been stampeded into outside selling. Suddenly realizing that everything from shoes to ships and scaling wax is being sold in this manner, they have come to fear for their own futures unless they immediately adopted the method. To many, it looked easy; all they had to do was put in a want advertisement,

- Don't Do It If You Don't Do It Right*
- Don't Hire Canvassers Haphazardly*
- Weave This Branch of Selling Into Your Business*
- Supervise It Constantly*
- Pay Your Men Well*
- Control Your Stock Carefully*
- Do Fifty Per Cent. of Your Demonstrations Result in Sales?*
- Give Crew Manager a Small Salary Plus a Commission*

select a few men, and turn them loose. I don't have to tell you what usually happened. A few learned from costly experience and finally got into the swing of things when they gave this phase of their business the attention it deserved. Others failed dismally, gave up outside selling in disgust, and continued as before."

Green's Service to Dealers

With this in mind, one of the first things Mr. Green did was to put a man in charge of an outdoor selling department to be conducted both as an experimental station and as a service to local dealers. Methods were studied and tested through dealers who cooperated. Then, when the time came, leading dealers were "sold" on the proposition and urged to sponsor outdoor selling crews to be selected and trained for them by Parks & Hull. In several cases, these crews remained under supervision of the wholesale house for several weeks after going into operation. Our story, however, deals not so much

with these facts as with the general observations Mr. Green has thus been enabled to make with regard to door-to-door selling on a city-wide scale.

As indicated at the start, he has found that, above all, this phase of radio merchandising requires the closest sort of supervision. Most of those applying for a selling job of this kind are not of the highest type. Far from it. Many have made a failure in practically everything else they have tried.

Consequently, it pays to make a special effort to pick the best possible people for the work in the first place. Secondly, the proposition offered to them must have merit. There must be a reasonably good opportunity for those qualified for the work to make a fair living at it.

Next comes the training of the men and a close contacting of them by the store as a means of keeping a definite check on their activities. Among the Baltimore dealers with whom Mr. Green has worked, the training has been done by Parks & Hull but the checking up on the men has been largely up to the individual dealer.

Even with these precautions, there has been a high rate of turnover among the house-to-house salesmen—although not nearly so high as it might be otherwise. It is only necessary to compare results of dealers in other localities who have embarked upon the plan in a haphazard fashion with those in Baltimore to realize the truth of this assertion.

Personal Turnover

"After all," says Mr. Green, "this turnover among salesmen is not as bad as it might be. That is, providing the dealer keeps in close touch with them. Each salesman of fair ability has a few good sales in him. These come almost as a matter of course. Perhaps they may be made to relatives or to friends but, as far as the dealer is concerned, they are sales which probably would not come to him otherwise. As long as the dealer sees that they are not forced sales and that the salesman has not attached a lot of 'strings' to them in order to get a commission prior to his departure for parts unknown, things are not so bad.

"This is not a defensive statement for a high rate of personnel turnover. It stands to reason that the more successful salesmen the dealer can develop, the better it will be for him. I only mention it as a redeeming feature about one of the worst phases of outdoor selling."

To the dealer, outdoor selling as recommended by Mr. Green means that he will have to carry a larger stock and be reconciled to a very necessary increase in office overhead. Two crews of, say, seven men each should keep a goodly number of sets out on demonstration. Usually, it is necessary for the dealer to have from 25 to 50 or more sets on hand, depending, of course, on the extent of his proposed efforts in taking his store to the homes of prospects. These

transactions naturally require quite a little additional book-keeping, model forms having been prepared for this purpose under Mr. Green's direction. (Four of these forms are illustrated on the first page of this article.) The importance of knowing just where all sets are at all times and their exact status can hardly be over-emphasized. Yet it is a factor many dealers neglect.

Contrary to the practice of some dealers, Mr. Green urges salesmen to make as many demonstrations as they can. However, these are not made indiscriminately. The simple expedient of paying salesmen commissions ranging from 10 to 15 per cent. of the sale largely takes care of this. Similarly, dealers keep a close check on the length of time sets are allowed to remain in homes, usually limiting this to two or three days.

The fact that from 40 to 50 per cent. of demonstrations made under these conditions result in sales is, in itself, sufficient vindication of the method. Payments to salesmen run from \$25 a week to three and even four times that much in exceptional cases.

Selling Assistance

How much direct selling assistance can the dealer give to his representatives?

"Usually not a great deal," says Mr. Green. "The store can supply a few leads but the one outstanding reason for employing door-to-door crews is to get to people who cannot be reached through the regular store sales channels. It is largely up to the salesman's ingenuity to which may be coupled his preliminary training, literally to search out prospects 'where they ain't.' This requires a lot of perseverance and foot-work. If a good salesman makes enough calls, however, he'll find some prospects. Then it is up to him to turn them into customers. Meanwhile, it is up to the dealer to see that he is making enough daily calls, in addition to keeping a check on all demonstrations."

Crew Manager Receives Salary

In most instances, it has proved advisable to have salesmen work in crews under a manager who receives a small salary plus a commission on all sales produced by his men. This assures a careful, intensive working of all available territory. It likewise prevents a single salesman skimming off the cream, skipping haphazardly here and there.

Table model sets are usually used in demonstrations for convenience in handling. After the prospect has been sold on the idea of owning a radio, the selection of a cabinet is a comparatively simple matter.

"House-to-house selling does not necessarily mean high-pressure selling," says Mr. Green. "There has been too much of that attempted in the past.

(Concluded on page 122)



L. G. PACENT (Pacent): "The home talking picture field is on the threshold of a great development. Equipment for home use is perfected and all that is needed is for leading producers to supply pictures and discs."



A. A. SCHNIDERERHAHN (Schneiderhahn Co): "Women buy 65 per cent. of all radios."



FLOYD A. ALLEN (General Motors): "Too many superlatives and too much braggadocio appear in altogether too many advertisements."



GEORGE E. HULL (Parks and Hull): "Know your product! There is no better way to sell it successfully."



DR. LEE DEFORST (DeForest): "I believe the radio industry has made tremendous strides during the past twelve months. The industry has little to worry about in the matter of market saturation."



CHARLES T. LAWSON (Day-Fan): "I feel that the kind of advertising program a dealer should put over is the kind that runs on a regular schedule throughout the year."



C. E. STEVENS (Stevens): "The electrodynamic loud speaker is here to stay. We have by no means exhausted its possibility."



ERNEST KAUER (CeCo): "If . . . the average broadcast sponsor is more intent on selling soap, tobacco, oil, or shoes than he is in the interest of the radio public, then the solution is to make the radio industry economically responsible for broadcasting's cost."

Below are pictured a group of three officials of Thomas A. Edison, Inc., and a California distributor of Edison products. From left to right they are—Alfred Hand, advertising manager, H. R. Curtiss, Los Angeles distributor for Edison, W. H. Meadowcroft, secretary to Thomas A. Edison, R. R. Karch, assistant to the vice president, and A. L. Walsh, vice president and general manager.

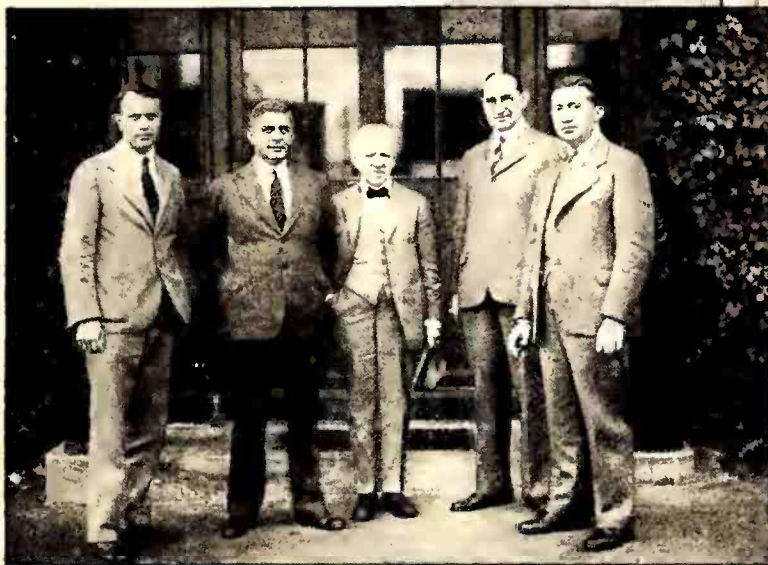

Powel Crosley, president of the Crosley Radio Corporation has enlisted the services of several of America's foremost artists to test Crosley receiving sets in their homes and report on the fidelity of reproduction. From left to right those shown below are—George Gershwin, Alma Gluck, Efrem Zimbalist, and Powel Crosley.

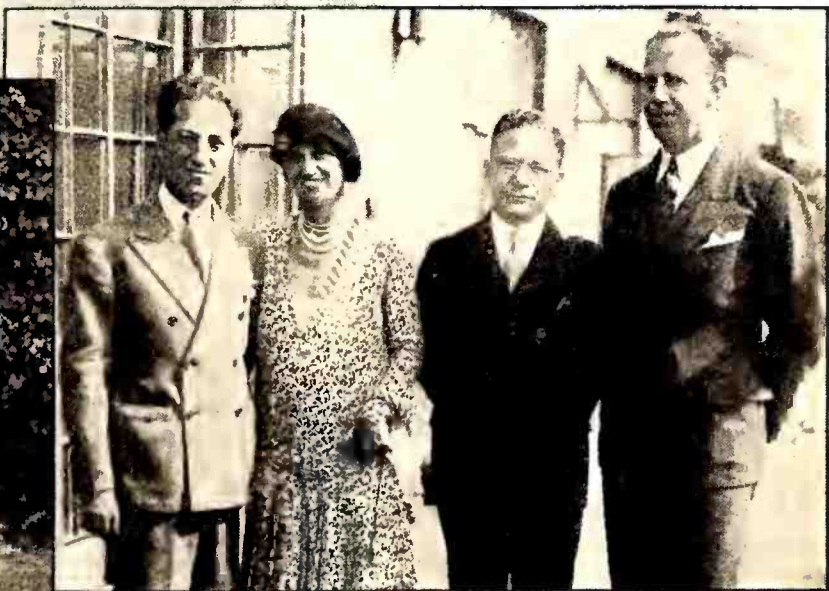

Ray Thomas, distributor for Alwater Kent in southern California, staged a radio show in the foyer of the Paramount theater in Los Angeles during the week preceding the National Radio Show in that city. This picture shows a corner of the exhibit.



Ingram Bonder, seventeen-year-old student of the College of the City of New York, is shown below at the controls of the first commercial television receiver with Dr. Lee DeForest supervising him at the moment. The receiver was presented to him as the first-prize award in the Jenkins Prize Essay Contest.



Count Felix Von Luckner, the daring and gallant sea raider of war days, and now a roamer of the Seven Seas, receives William L. King, sales manager of the May Distributing Corporation, Philco representative in New York, who presents him with a Philco Highboy De Luxe. This picture was taken on the Count's ship, the Omelia, in New York harbor.



A FEW INTERESTING RADIO PICTURES OF THE MONTH

ADVERTISE WHAT YOU HAVE TO SELL

As told by a Well-known Account Executive



LAST SUMMER two complete and different advertising campaigns were exhibited in proof form to radio jobbers and dealers throughout the country. One of these campaigns was noisy. It shrieked and yelled, roared and bellowed. Big black headlines. Superlatives. Prices hitting you in the eye. The kind of advertising you call either "cheap," or "two-fisted selling," depending on whether you like it or not. The jobbers and dealers liked it, unanimously.

The other campaign was quiet and dignified. It didn't raise its voice. Dainty, not domineering. It certainly made the reader think the Raspless Radio was a great instrument, but the amount of black ink it used wouldn't have darkened a gnat's eyelashes. Nobody liked this campaign except the manufacturer and his advertising agency, and so of course it wasn't run.

The two-fisted selling campaign went into a lot of expensive newspaper space. All bills were paid by the manufacturer, who sat back and waited for Western Union to begin delivering orders for carload lots. But the wires were silent, and even the mail carrier noticed nothing unusual. No public clamor was raised over the Raspless. In fact, the Raspless people and their agency claimed the advertising had no effect whatever, but that probably is an error. Certainly there must have been some cause of the universal decision not to buy Raspless Radios.

The Third Campaign

Swiftly—speedy folks, these advertising men!—the trade's pet choice was discarded. A third campaign, even more high hat and ritzy than the one that had been despised, was prepared. It made you think the only way to get into society was to buy a Raspless. Dignity, prestige, smartness, sophistication, and a lot of other ten-dollar words could be and were applied to it. If the reader wanted to know the price, the number of tubes, and whether they were screen grid, he had to hunt, and provide his own magnifying glass.

At the present writing this campaign is running. Western Union's business has picked up, and the mail carrier has asked for a wagon. It looks like a success.

There is a moral in this for all concerned, and here it is, in one of its 59 varieties: "Don't monkey with the other fellow's business."

A manufacturer's advertising is very much his own busi-

ness. A dealer's advertising is his own business, too. This is rather well known in other lines, but in the radio industry the acquisition of the knowledge seems to cause some of the growing pains now felt.

Fundamentally, the purpose of advertising is to sell something. Advertising will fail if it tries to sell something the advertiser cannot supply.

Often, and in fact usually, a radio manufacturer has for sale something that none of his dealers have, and each of his dealers has something that none of the other dealers have. This is true in spite of the fact that all handle an identical product, which is to be sold to the public at presumably identical prices.

What the Manufacturer Sells

This seems paradoxical. But let's list the things the manufacturer has for sale to the public—to the public, notice, and not to the jobber or dealer. Here is the list:

- 1—What his radio receiver will do for its owner—performance and appearance. This is where most of the surprisingly ineffective superlatives are spilled.
- 2—His own knowledge, skill, and experience in radio design and manufacture, and the ideals that move him.
- 3—His own reputation for (a) making good radio sets, (b) giving value for the money, (c) being up to date, (d) standing back of his products.
- 4—His reputation and standing in other fields, if any.

You will note that this list does not include Raspless Radio Receivers, for the good reason that the manufacturer does not sell them to the public. His dealers do that. The distinction is vital, and if you will contemplate the kind of advertising done by manufacturers who do sell direct to the public you will be convinced that the difference is a very real and important one.

What the Dealer Sells

For the sake of simplicity let us pass over the jobber and list what the dealer has for sale:

- 1—Raspless Radio Receivers—at last!
- 2—Service, swift and sure.
- 3—Local reputation for (a) selling good goods, (b) charging fair prices, (c) keeping customers satisfied, (d) in general, fair dealing.

Compare these two lists, and you will find not a single item

A True Story of an Advertising Campaign Which Shows that the Factory Sells Something Different from the Dealer. The Manufacturer Says, "Go Get It," and the Dealer Says, "I Have It."



in common. It is true that in selling a Raspless to a customer the dealer will repeat more or less what the manufacturer says about performance and appearance, but the dealer's attitude is "I've got a Raspless for you," while the manufacturer advises "Go get a Raspless for yourself," frequently adding a list of dealers to go to.

No, the manufacturer and dealer are two different people, and they have two different stories to tell, in two different manners. No dealer can know the manufacturer's story well enough to tell it, nor even to say how it should be told. If the dealer acts as a guide he but leads the manufacturer astray along the paths of retail advertising. And conversely, the manufacturer will lead the dealer up the wrong advertising alley if he gets a chance.

Hundreds of thousands of dollars have been wasted this year and more probably will be thrown away next year on the preparation of so-called "dealer advertising." You know—the ready-made stuff that comes to you in the form of a big book of proofs. Each advertisement has at the bottom a blank space (usually too small) bearing the hopeful words "Dealer's signature here." Just outside the border of each advertisement is a number something like this: "AX37—4201i—10" X 3 cols." You can't remember this number long enough to copy it down but you are supposed to write it on an order blank.

You Write Your Own

All the advertisements are too big, the prices are wrong, and you don't like the text, somehow. So you decide not to use the ready-made stuff, and quite right you are, too. You order one electrotype of the receiver, and sit down to write your own advertisement. When you get through it is your advertisement. It expresses you and your establishment. You may not be conscious of it, but it reveals the kind of person you are, the kind of shop you run, and attracts the kind of people who would like to deal with you and with whom you would like to and can do business.

How can an advertising man who never saw you write such an advertisement for you? How can factory-made advertising do a job for you, for Bill Jones over on Commercial Street, for John Smith in the next county, and for Jim Brown in the neighboring state? It can't, and you recognize it when you reject the advice of the manufacturer, throw away the ex-

pensive book of ready-made advertisements, and write your own.

Startling advertisements have been produced in this way. Some of them have been given the raucous horse laugh by so-called advertising experts who were not expert enough to look up results and find how those advertisements paid.

Sincerity Pays

There is nothing like sincerity. It is absolutely essential in advertising, which is one field where the hypocrite has a hard time of it. If you don't believe in what you advertise, your disbelief will be seen or felt or heard or tasted or realized by your readers. It's funny how those things work. Hypocrisy will show, if it is there, in even the most professional and sophisticated advertising job.

But genuine sincerity has the same revealing quality. You can't hide it, and that's a comfort. I've seen some clumsy, ungrammatical and crude letters and advertisements that just made you want to run into the store, throw your pocket-book on the counter and say, "Quick, give me some of that!"

Every once in a while every advertising man discovers that "unprofessional" advertising can be tremendously profitable, and if it causes him any astonishment he should be digging ditches. Real folks with real goods will make money selling them, and they will make the most money if they do a lot of advertising and do it themselves, getting into the advertising the genuine, honest qualities that are in themselves and their merchandise.

However, I do not mean that there is no way for a merchant to get good advertising except by doing it personally. There are plenty of fine dealers who get outside advertising help—only it is not very far outside. They employ local advertising men. Some of the bigger dealers are able to interest local advertising agencies and obtain all their highly developed facilities. Other dealers have found advertising writers in their neighborhoods, and put their advertising on a man to man basis, which is tremendously successful—if you get the right man.

I know a tailor, who, soon after his small start, made arrangements with a local writer to exchange suits for words. Neither knew it at the time, but the tailor got the services of one of the greatest advertising writers this country has

(Concluded on page 120)

The MARCH

Why We Have Rumors of Mergers
Recent Progress Made By Broadcasting

What Is Right With Broadcasting

WE INCLINE TO stress the unfortunate development of advertising halitosis in broadcast programs in the hope of encouraging a cure. Now and then, we should pause to admit the progress which is being made in the development of constructive broadcasting programs.

We were especially pleased to observe the advertisement placed by B. J. Grigsby, of the Grigsby-Grunow Corporation, calling the attention of the general public to the growing hostility of sports promoters to radio broadcasting. Several prizefights, worthy of broadcasting, have been withheld from the air and it is understood that the last World's Series was the last to be broadcast by the leave of baseball magnates.

The sporting world may continue to cooperate with broadcasting or not as it pleases. Failure to do so will only bring about a forcible demonstration that the public support gained by broadcasting has been of immense commercial value to sports. Sports promoters may, some day, be forced to seek the help of the microphone, now so freely presented to them. Then it will be the broadcast industry's opportunity to quote its usual rates.

In the end, broadcasting will not be denied, even if broadcasting interests must stage their own contests for the benefit of the immense radio public. This idea may seem far fetched at the moment, but there is already precedent for such a suggestion. Five years ago, the motion picture world, the stage, and the phonograph industry were fighting radio. To-day, they have become an inextricable part of it through coöperation, merger, or outright purchase. Mr. Grigsby has performed a service in calling the emphatic attention of the public to the present situation but the fact remains, whether his plea to the sports industry is successful or not, that radio has progressed to the point that it cannot be denied.

One of the bright spots in program progress is the more ambitious presentation of Damrosch's musical appreciation hours. They are a Friday morning feature, 11 to 12 Eastern Standard Time. Four courses are being conducted simultaneously for students ranging from the third grade of public school to high school and college. A 68-page manual has been prepared for teachers which is a model of comprehensiveness and practical value, enabling instructors to conduct class work closely coördinated with Dr. Damrosch's presentations. Progressive dealers will sell substantial orders to their local Boards of Education on the basis of these programs.

Another bright spot is the rapidly increasing roster of 50,000-watt broadcasting stations, of which WABC, WTAM, KNX, WLS, and KSTP are the latest additions, all of these having secured construction permits from the Federal Radio Commission during recent weeks.

To be classed as not such good news for broadcasting is the allowed purpose of WRNY, WGBS, and WCFL to upset the clear-

channel principle by seeking assignments on channels assigned exclusively to other zones. These cases are based upon the precedent established by WGY. We have gone into its effect fully in previous issues and have been pleased that, so far, the WGY decision has not seriously disturbed the peace of the allocation situation. Despite the pressure in Congress for power limitations and the destruction of the clear-channel principle, we fail to see the logic of favoring 650 localities with local services, some of them with as many as twenty, covering in the aggregate only a small part of the United States, while every part of the country might be served with six or eight programs through a geographically equalized service of powerful broadcasting stations on exclusive frequency channels.

Readjustments in the Industry

ONE REASON that so much credence is given to rumors of mergers of leading radio manufacturers is because the merger is an inevitable evolution of the industry which must sooner or later take hold on a widespread scale. The general trend in all industrial and business organization is toward merger, consummated with the objective of increasing efficiency through combination of manufacturing facilities or of sales forces or of both. Other mergers are undertaken as a means of preserving uneconomic units individually unprofitable but valuable in combination with other successful units.

The significance of mergers is best judged by the economies which they effect. Statistical analysis of mergers in all classes of industry indicates that more often than not the profits of the combined units are less than the sum of the earnings of the individual units of which they are composed. In the long run, however, bigger and more efficient businesses are built up because such mergers generally work out in practice to be the gradual discontinuance of inefficient and uneconomic units.

The radio industry is full of such units. The number of set manufacturers is excessive. The concentration of business in the hands of a few leaders is becoming more and more marked, although numerous small units still function. In the long run, ten or twelve manufacturers will do the vast bulk of the business and it would not be surprising if, within five years, four manufacturers do eighty to ninety per cent. of the total radio business. At least one of these may well be a company not now an active or outstanding factor in the field.

As the number of manufacturers narrows down, the value of the retail distribution franchise rises. Consequently, the dealer who concentrates on lines which will be a permanent factor in the industry, selected because of a long established record of leadership or because of outstanding engineering and sales ability manifested by an up and coming concern, is laying the basis for a permanent and valuable sales franchise.

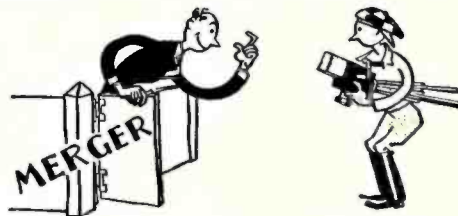
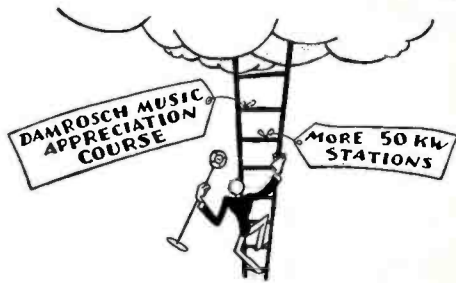

OF RADIO

Let's Kill Putrid Announcements
A Few Pointers from the Auto Industry

An influence which has prevented consummation of the large number of mergers rumored is the personal pride attached to names of leaders in the industry. A man who has built up a business around his name is not likely to surrender it to form an unidentified unit of a group. But the inevitable must be faced sooner or later because the present situation of excessive number of brands leaves the field wide open to ambitious and progressive newcomers who obtain leadership by the adoption of modern business methods successful in other lines of industry.

No more obvious course lies open than a novel approach to the distribution situation. The agency plan of distribution, similar to that adopted by the automotive industry, may ultimately become the method employed by the radio industry. This will be possible when the number of outstanding names in the industry is reduced to a handful and when the unit of sale in radio becomes larger.

While there has been a decidedly marked tendency toward lower average list prices, the radio receiver may sooner than we expect be a part of a combination of devices now sold as separate units or almost wholly undeveloped from the commercial standpoint. We have described previously in these columns what, in our opinion, will be the ultimate occupation of the radio industry, the production of a home-entertainment machine which combines radio program reception, phonograph reproduction, television, home motion picture reproduction, and recording devices for preserving visual and tonal programs for later reproduction. For example, the hour selected for broadcasting of stock market or weather reports may not necessarily suit the convenience of the listener but, if he could arrange to have these reports recorded at whatever hour they are broadcast, he may later listen to the recording at his convenience.

If engineering development is able to make a practical combination of the numerous functions to which radio- and audio-frequency amplifiers can be put in the home, the outcome will be a relatively expensive device suited to agency distribution. Hence we need look not only to the radio industry itself for logical mergers, but to its absorption by or of units in associated industries such as motion picture cameras and projectors, phonograph recording devices, television, and still picture recording.

Roasting Will Do It

THE FULL BLOOM of the domestic market for radio receivers awaits the zenith of progress in the development of radio programs. Although motor cars cost ten times as much as radio receivers, six times as many are sold! What are the obstacles in the way of tenfolding the sales of radio sets?

Prejudice! Ancient prejudices must be removed! Radio

advertising irritants, so harmful to digestion and disposition, must give way to American progress! Broadcast programs must be made safe so that women, children, and even infants can enjoy them without irritation! American intelligence will force the removal of poisonous advertising announcements, spelled p-u-t-r-i-d, which are holding back thousands upon thousands from joining the great American radio family.

Roasting will do it! Roasting the greedy advertiser at every turn, by letter to broadcasting stations, to sponsors, to newspaper and magazine editors, and to dealer outlets, until his blood is boiling in a carefully regulated oven. Roasting will free radio of putrid programs. Whoever you are, listener, dealer, manufacturer, reach for your bitterest Sucky Pipe take a mean swallow, and write your honest opinion of the sponsors who exceed the bounds of propriety. Do your bit to check the verbose and tedious advertising announcements which are holding back the growth of the radio family and reducing the hours radio receivers are being used in every intelligent American home!

In Spain a government regulation prohibits stations from broadcasting more than 100 words of advertising per hour. We hope that American advertisers will learn how to govern themselves properly before a similar regulation becomes necessary in this country.

A Lesson for the Radio Industry

A LEAF FROM the page of the experience of the automobile industry may well be adopted by radio, especially if the former becomes a factor in radio receiver distribution. Motor car manufacturers take their dealers into their confidence. They assure the stability of their market by giving the dealer definite warning of changes in models and giving him full opportunity to unload. The automobile manufacturer shares some of the losses occasioned by the introduction of new models by paying a bonus based on the number of cars sold and in other ways. Few automobile dealers have old models two or three months after the introduction of new models. Another item of sales policy which the decentralized radio industry cannot yet adopt is the automotive industry's method of assigning definite sales quotas to definite territories, thus eliminating order takers from automotive distribution. Also, one need hardly do more than privately whisper an expression of dissatisfaction with one's motor car to bring about visits from half a dozen dealers representing as many makes in a given territory. The radio dealer is still waiting behind his counter for the purchaser to come in and lay down his money. If a receiver distribution franchise were valuable, the dealer would have incentive to reach his quota and this could be accomplished only by going aggressively after business.—E. H. F.

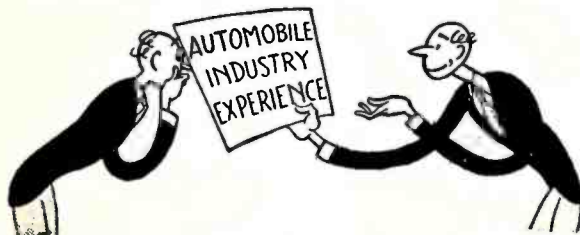
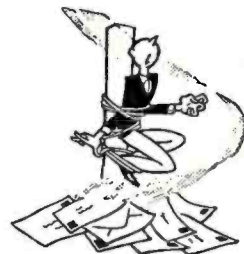

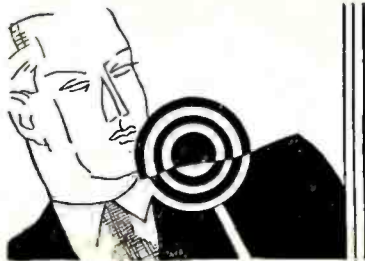

RADIO

RCA-VICTOR CORP. ENTERS THE FIELD

New Company Formed to Manufacture and Sell All RCA Home-Entertainment Apparatus

Effective January 1, 1930, all radio material in the home-entertainment field previously sold under RCA's name will be manufactured as well as sold by the RCA-Victor Corporation. Included in the new arrangements between Radio Corporation, General Electric, and Westinghouse, are radio sets, talking machines, records, and other devices in the home-entertainment field. This represents a new step in the activities of the enlarged program of the RCA subsidiaries. The 20 per cent. manufacturing profit retained by General Electric and Westinghouse in the making of radio units exclusively sold by RCA will be removed and the new organization called the RCA-Victor Corporation will encompass the research, engineering, manufacturing, and selling activities which have hitherto been distributed among the constituent companies.

The new company will be headed by E. E. Shumaker, now president of the Victor Talking Machine Company. Other officers are: J. L. Ray, H. C. Grubbs, and Alfred Weiland, vice presidents. Mr. Ray is at present in charge of all selling activities of Radio-Victor. Mr. Grubbs is a vice president of Radio-Victor in charge of the Victor Talking Machine Division, while Mr. Weiland, formerly vice president in charge of production for Victor, will have charge of all manufacturing activities. The engineering department will be headed by W. R. G. Baker, at present with General Electric.

In a joint announcement by the heads of RCA, General Electric, and Westinghouse it was said: "Of major importance is the unification of the radio research and engineering facilities of General Electric, Westinghouse, RCA, and Victor so that the same staffs which have produced so many of the major contributions to science and engineering in radio and the entire home-entertainment field will not only cooperate in the future but will actually be consolidated under a single unified direction. The new company will continue, however, to get full benefit in its field of the broad research facilities of General Electric and Westinghouse."

Executive and sales headquarters of the RCA-Victor Corporation will be in New York, probably in the new building which is to be erected by RCA at Lexington Avenue and 51st street in the near future. Fifty per cent. of the stock in the new company will be owned by RCA—the holding company for all the radio group—30 per cent. by General Electric, and 20 per cent. by Westinghouse. Present sales of the constituent units of the new company total more than \$50,000,000 annually. The Camden plant of Radio-Victor now employs more than 13,000.



General view of the plant of the Victor Talking Machine Division of the Radio-Victor Corporation of America.

The merger may increase this number to 19,000.

Speculation in the industry is now centering around the probable moves of General Electric, Westinghouse, and Western Electric. Will the radio plants of these companies continue to make sets and appliances, to be sold under the well-known trademarks of each, in open competition with the products of the new RCA-Victor corporation? Will Western Electric enter the retail field with a line of tubes and super-heterodynes? One well-

known figure in radio who would not be quoted remarked that in his opinion another twelvemonth would see separate radio sets (in each of which the Radio Group has strong financial interest) made and marketed by the following: General Electric, Westinghouse, Western Electric, RCA-Victor, and General Motors Radio Corporation. "This new step on RCA's part will enable them to make more sets at a lower price and get them on the market quicker than ever before," remarked one radio observer.

Atwater Kent Not Contemplating Merger

Over the signature of A. Atwater Kent, the following statement is made regarding the rumors that the Atwater Kent Manufacturing Company was considering a merger with other prominent radio set manufacturers.

"Varied rumors would seem to be afloat that I am contemplating a merger with one, or another, or several radio manufacturing concerns.

"Once and for all, I wish to state that there is absolutely no basis whatsoever for such reports. I have conducted my own business for more than twenty-seven years and I contemplate no change in my policy.

"I am getting a lot of enjoyment from personally directing our constantly increasing force, which now numbers many thousands, both in our plant and in the field.

"I have no idea of either dividing the direction of my business or the responsibilities which it involves."

Radio Trade-in Values

A compilation of trade-in values of radio receivers has been made by *Western Music and Radio Trades Journal*. The trade-in values are determined from answers to a questionnaire sent to Western dealers and jobbers. These trade-in values have been printed in loose-leaf form and can be obtained for \$5.00, the price including corrections for one year and one year's subscription to the journal.

Stromberg To Make Aircraft Radio Sets

The Stromberg-Carlson Telephone Manufacturing Company has made a special arrangement with the A. T. & T. Co. and R.C.A. to manufacture and sell radio receivers for the Aircraft Radio Corporation, Boonton, N. J., for the reception of beacon signals, weather reports, etc.

Television Broadcasting

The Freed Eisemann Radio Corporation will broadcast regular television programs from their short-wave station, w2xcr, located at the Allwood, N. J., plant of the Corporation. Transmission will take place on 2000-2100 kc. and 2850-2980 kc.

Arcturus Increases Advertising

According to a recent report from J. Geartner, advertising manager, the Arcturus Radio Tube Company has increased its newspaper advertising from 185 newspapers in 164 cities to 413 newspapers in 357 cities.

Cloth Diaphragms Patented

A patent on making loud speaker diaphragms of fabric has been granted to the Steven Manufacturing Corporation, according to the statement of Clifford E. Stevens, treasurer and chief engineer of the organization.

0-1

Alexanderson Patent Upheld

According to the Radio Corporation of America, a decision has been handed down by the Privy Council, the highest appellate tribunal in the British Empire, upholding the Alexanderson tuned-radio-frequency patent as against the Schloemilch and Von Bronk patent.

The case went to the Privy Council in London on appeal from the decision of the Supreme Court in Canada. In the Canadian litigation, the Alexanderson patent was sustained by the lower court, this decision was reversed by the Supreme Court of Canada, and after much controversy it was taken by the Privy Council in England.

The two patents had already been considered by two Federal District Courts of the United States both of which had decided in favor of the Alexanderson patent.

R.M.A. Credit Service Expanded

Leslie F. Muter, chairman of the R.M.A. Credit Committee, announced that the Association's credit and collection service is to be expanded in an effort to reduce further the credit losses of its members. These losses amount to several million dollars annually, according to the committee.

Weekly bulletins giving complete credit and collection information in confidence are exchanged between the radio manufacturers through the central office of the Radio Manufacturers' Association, and frequent meetings of the various regional credit committees of the R.M.A. are held. By centralizing collections, employment by manufacturers of individual attorneys is avoided with consequent economy in the collection of claims.

New Radio for Chrysler Car

Automobiles manufactured by the Chrysler Corporation will be equipped with a special radio receiving set through an arrangement made with the Transitone Company, in which Chrysler has acquired an interest.

Personal Notes

Vernon W. Collamore, Atwater Kent sales manager, left New York on September 28 for a three-month vacation in Europe.

Otto Paschkes, president of the Polymet Manufacturing Corporation, sailed on the Bremen on October 4 for an extended tour of the Continent.

W. D. Powers has recently joined the CeCo Manufacturing Company, Inc. as merchandise manager, taking on some of the work formerly in the hands of the advertising and sales departments. Mr. Powers was sales manager of the Providence Company.

W. A. Brooks has just been appointed assistant to Alfred Marchev, president and general manager of the Temple Corporation. He will assume part of the responsibility now on Mr. Marchev's shoulders.

J. B. MacQuen is now a special representative for the Crosley Radio Corporation in the Arkansas territory. His headquarters will be at Little Rock.

Taylor C. White is the manager of the Seattle Branch of the Edison Distributing Corporation. He covers Washington, Oregon, and Idaho.

F. Clifford Estey, who has the distinction of being the first radio sales manager in the United States, has been made assistant to A. R. Hill, president of the United Reproducers Corporation. Mr. Estey was formerly assistant to the president of Crosley Radio Corporation and for the last few months has served as radio counsel for the Geyer Advertising Company, Dayton, Ohio.

Otto Schlair, formerly in the patent department of the Westinghouse Electric and Manufacturing Company, succeeds Captain Howard Angus as director of patent developments of the Radio Corporation of America. He has also taken over the responsibility of the R. C. A. licenses.

Morris S. Owens has been appointed field supervisor by Gross Biennan Inc. He will contact the entire New York and New England territories for Stromberg-Carlson. Mr. Owens entered the talking machine field in 1910 with the New York Talking Machine Company. He later owned several stores in Brooklyn.

At a recent meeting of the Board of Directors of Electrad, Inc. Henry G. Richter was elected vice president in charge of engineering, and Edward Metzger, vice president and general manager in charge of credits, general office and factory supervision.

Alfred Suekoff has joined the Chas. Freshman Radio Stores, Inc. He will serve in the capacity of general sales manager with complete jurisdiction over the entire chain of 12 stores.

F. J. Bullivant has been appointed sales manager of the Trav-Ler Manufacturing Corporation. Mr. Bullivant in assuming his new duties will retain

Rola Wins Over Lektophone

The Circuit Court of Appeals for the ninth circuit has affirmed the decision of the United States District Court for the northern district of California, southern division, which was to the effect that the Rola Company did not infringe the patents of the Lektophone Corporation in the design and construction of their loud speaker.

The Southwest Radio Show

The Fifth Annual Southwest National Radio Show was held in St. Louis during the latter part of September. There were 52 exhibits of which 46 were radio manufacturers. The jobbers in the St. Louis territory paid for eighty per cent. of the booth space and ninety-six per cent. of the decorating expense. The average daily attendance was 20,000. The maximum attendance for any single night was 26,954. From figures gathered it was estimated that over \$750,000 worth of business was transacted consisting largely of set sales by jobbers to dealers.

British Branch of R.F.L.

L. M. Hull, vice president of Radio Frequency Laboratories, Inc., Boonton, N. J., has just returned from England where he established a sister laboratory to the R.F.L. The English company will be called Radio Frequency Laboratories, Ltd. It is planned to have an all-British technical personnel which will work in close cooperation with the American laboratories.

active charge of the sales department of the B-L Electric Manufacturing Company, builders of rectifying devices.

Henry W. Butterworth, formerly a salesman for Wilkening, Inc., Crosley-Amrad distributors, of Philadelphia, has joined the staff of announcers for wjz of the National Broadcasting Company.

Herbert E. Fenner, general service manager of the American Bosch Magneto Corporation at Springfield, Mass., sailed for South America.

Edmund O. Lesquier, general credit manager of the American Bosch Magneto Corporation and Herbert Shoemaker, Chicago sales manager, recently flew to Minneapolis. Mr. Lesquier made first-hand contacts with distributors and dealers and gained special information for Bosch Radio Better Business Bulletin No. 7.

Henry Wolff is directing radio sales for Frazar and Company of San Francisco, who, as manufacturers' representatives, act as direct salesmen, calling on the larger domestic outlets on the Pacific Coast. Mr. Wolff was formerly Pacific Coast sales manager for the Jensen Radio Manufacturing Company, with a prior record of having organized the radio department for Sherman Clay & Company.

J. W. Hitchcock has been appointed assistant sales manager, in charge of Atwater Kent distributor relationships. E. E. Rhoads has been appointed assistant sales manager in charge of Atwater Kent territory managers and senior and junior salesmen. He will direct the Atwater Kent sales organization in the field. A third new assistant sales manager is F. E. Basler, who is in charge of the home sales office.

Carl Dreher, formerly chief engineer of RCA Photophone, Inc., and for the past six months in charge of sound recording at the above company's studios in New York City, is on an extended trip to Hollywood. He is now associated with the technical side of this company's moving picture productions and will survey and technically supervise the many recording activities of RCA Photophone, Inc., in the leading West Coast studios.

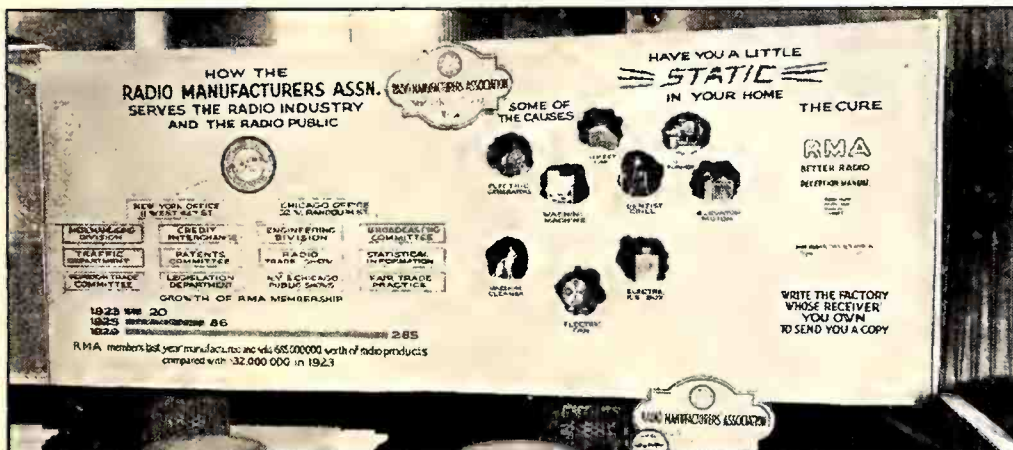

This display was used by the Radio Manufacturers' Association at the New York and Chicago radio shows to tell spectators how the association serves the radio industry and the public.

R.M.A. Working to Raise Radio Advertising Standards

Constant efforts and much progress are being made to raise the standards of radio advertising, according to Morris Metcalf, of Springfield, chairman of the Fair Trades Practice Committee of the Radio Manufacturers' Association. In coöperation with Better Business Bureaus and other organizations, Mr. Metcalf, outlining the goal of the Radio Manufacturers' Association for the best ethics in radio advertising, believes that real progress is being made not only in this endeavor, but in bettering general trade practices in the selling of radio and also in adjusting disputes between members and other interests.

"It is estimated that between \$20,000,000 and \$25,000,000 is spent annually by radio manufacturers in advertising channels," said Mr. Metcalf. "In the hectic and unstable days of the industry advertising excesses crept in, as in other new industries. This condition has largely been changed.

"The sincere personal acquaintances and friendships that result through association work tend to eliminate a good deal of sharp practice, false statements, and unfair competition among the members.

"The radio industry is peculiar in many ways, and because it deals with a newly discovered force and highly technical apparatus, the public knows very little about it and is easily misled and confused regarding radio merchandise. Therefore, there is more than the usual need for frankness and fairness in our dealings with the public, and I am glad to say that, in the main, members of the Radio Manufacturers' Association practice this policy."

An Interesting Sales Bulletin

One of the most readable and interesting sales bulletins issued by a distributor is that sent out regularly by J. H. Burke Company, 221 Columbus avenue, Boston, Atwater Kent distributors. The regular message is prepared in the form of a broadcast and carefully preserves the style of the usual ether announcement. The Burke Company report that this friendly feature is very popular with their dealers.

Old-Fashioned Tally-Ho Startled Philadelphia Business Men



Atwater Kent scored a scoop during their Salon Showing Week in Philadelphia by their novel presentation of a half-century-old tally-ho which was authentic down to the least detail. This device, embellished by several attractive signs announcing the National A.K. Cabinet week, was manned by a ducky coachman and footman, and was drawn by four prancing horses through the busy down town streets.

Activities of R.M.A.

Choice of Atlantic City for the 1930 R.M.A. convention and trade show, protection of the radio industry and public against harmful radio legislation, stimulation of broadcasting features and other trade promotion, pressure of the R.M.A. patent interchange plan, and the semi-annual convention of the Engineering Division, were the highlights of the Radio Manufacturers' Association's crowded calendar which were considered by its Board of Directors and Committees at the Hotel Astor, during the week of the annual Radio World's Fair at Madison Square Garden, September 23-28.

Stimulation of new and improved broadcasting features for the radio public, including measures to insure the public reception of features of national interest, such as sporting events which some private promoters are reluctant to have broadcast, was planned. In the development of radio programs, the Association's Broadcasting Committee, headed by B. G. Erskine, in conjunction with the Merchandising Committee, will enlist the further interest of manufacturers. It will also work with the chain broadcasting interests in securing broadcasts of all the national events.

The R. M. A. Board approved the plan presented by the Legislative Committee to establish an information service in connection with all radio legislation in the states and important cities. The new information service, already organized in over half of the states, includes the appointment of state chairmen from among the ranks of radio manufacturers, jobbers, or dealers, and the organization of committees in each state to advise the R.M.A. central office of the new radio legislation which is proposed. The new information service is being organized by A. T. Haugh, of Rochester, New York, former president of the R.M.A.

The Engineering Division, headed by its director, Walter E. Holland, of Philadelphia, had two days of busy sessions with about 150 prominent radio engineers in attendance. The members of this Division had a luncheon on September 26, and in addition separate meetings of all Committees were held and well attended.

Marvin Has World-Wide Distribution Chain

The Marvin Radio Tube Corporation representing the merger of seven independent tube manufacturers, now has, according to F. A. LaBaw, general sales manager, seventy distributors appointed in the United States and in addition have representatives in England, Belgium, France, Portugal, Spain, Italy, Switzerland, Germany, Japan, China, Australia, and the Philippines. By December, 1929, the number of distributors in the United States is expected to increase to 125.

Radio in Schools

E. C. Griffin, superintendent of schools for the State of South Dakota, has launched a campaign to put a radio in every South Dakota school. In the state there are some 5000 schools.



**E. O. Lesquier,
Credit Mgr.,
Bosch.**

Twenty schools in various parts of the country are equipped with RCA centralized radio apparatus, according to Quinton Adams, vice president, Radio-Victor Corporation. Some sixty

seventy other schools are planning to install such apparatus soon.

Recently Issued Patents

- No. 1,730,412. High-Frequency Broadcasting Over Power Lines. Robert D. Duncan, Jr., East Orange, N. J., assignor to Wired Radio, Inc., New York, N. Y. Filed December 5, 1923.
- No. 1,730,529. Sound-Absorbent Shield for Walls of Studios and the Like. Percy A. Robbins, Highland Park, Ill. Original application filed September 14, 1927, and in Canada August 17, 1927. Divided and this application filed November 30, 1928.
- No. 1,730,611. Art of Artificial Sound Reproduction. Herman S. Heller, New York, N. Y., assignor, by mesne assignments, to Electrical Research Products, Inc. Filed October 9, 1926.
- No. 1,730,837. Cathode for Electron Emitting Devices. Frederick S. Armstrong, River Forest, Illinois, assignor to National Union Radio Corporation. Filed August 31, 1928.
- No. 1,730,878. Modulation System. Robert L. Davis, Wilkinsburg, Pa., assignor to Westinghouse Electric and Manufacturing Company. Filed August 6, 1925.
- No. 1,730,903. Elimination of Disturbing Oscillations in High-Frequency Systems. Karl Schmidt, Berlin-Lichtenrade, and Walter Hahnemann, Berlin-Tempelhof, Germany, assignors to C. Lorenz Aktiengesellschaft, Berlin, Germany. Filed May 20, 1925, and in Germany, May 27, 1925.
- No. 1,730,976. Helical Drum Scanner. Charles Francis Jenkins, Washington, D. C., assignor to Jenkins Laboratories, Washington, D. C. Filed June 13, 1928.
- No. 1,730,987. Variable Band Amplifier. Frederick K. Vreeland, Montclair, N. J., assignor to Vreeland Corporation, New York, N. Y. Filed July 20, 1926.
- No. 1,730,994. Radio Frequency Amplification System. Francis J. Bullivant, St. Louis, Mo., assignor to Valley Electric Company, St. Louis, Mo. Filed November 5, 1925.
- No. 1,731,012. Radio Frequency Amplification System. Victor H. Laughter, Memphis, Tenn., assignor to Valley Electric Company, St. Louis, Mo. Filed January 16, 1924.
- No. 1,731,013. Radio Frequency Amplification System. Victor H. Laughter, St. Louis, Mo., assignor to Valley Electric Company, St. Louis, Mo. Filed November 5, 1925.
- No. 1,729,649. Program Transmission Over Wires. John F. Toomey and Henry E. Phelps, New York, N. Y., assignors to American Telephone and Telegraph Company. Original application filed November 11, 1922. Divided and this application filed November 12, 1923.
- No. 1,729,888. Getter for Vacuum Devices. Leon McCulloch, Pittsburgh, Pa., assignor to Westinghouse Electric and Manufacturing Company. Filed October 14, 1924.
- No. 1,728,617. Method and Apparatus for Elimination of Static Disturbances. Frederick W. Kranz, Geneva, Ill., assignor to B. Cumming, trustee. Filed June 9, 1924.
- No. 1,728,755. Speaker Unit. Carl F. Goudy, Flushing, N. Y., assignor to Pacent Electric Company, Inc., New York, N. Y. Filed April 19, 1928.

Production Figures

Bosch factories have been speeded up to maximum capacity according to a statement by G. W. Stackham, Pacific Coast division manager of the corporation. During a six-week period 107 carloads of Bosch receivers were sold in the Pacific Coast territory.

Production of loud speakers by the Oxford Radio Corporation, formerly the Joy-Kelsey Corporation, is proceeding at the rate of 2000 a day and will shortly be increased to 4000 per day. These loud speakers are being used by Zenith, Wells-Gardner, Montgomery Ward, and others.

It is reported that set sales by the Philadelphia Storage Battery Company for the year 1929 are expected to exceed 500,000 sets with a total retail value of about \$80,000,000. These sets are distributed through 10,000 dealers and distributors located throughout the United States and Canada. The company has signed a contract with the Commercial Investment Trust, Inc. who will finance the time-payment sales. C.I.T. also handle the time-payment sales of several other manufacturers including, R.C.A. Zenith, Eveready, and Sparton.



**A. T. Murray,
President,
Bosch**

Burtex diaphragms, a product of the Stevens Manufacturing Corporation, are now being made at the rate of from 15,000 to as high as 26,000 per day. Orders on hand total not less than 385,000 diaphragms, stated Clifford E. Stevens, chief engineer. He also stated that the company had supplied approximately 650,000 diaphragms to the manufacturers of Victor radio and phonograph sets.

According to reports the DeForest Radio Corporation's September sales were 37 per cent. above August. Gold Seal has \$6,000,000 of unfilled orders. Marvin reports receiving a \$1,000,000 tube contract. U. S. Radio and Television's September sales were about \$1,500,000, current production being about 2000 sets per day. Polymet reports September sales of about \$600,000 against \$96,000 two years ago. Temple's August shipments totaled \$712,836 against \$102,202 a year ago.

New Addresses

Ted Nelson, president of Pioneer Broadcast Service, Inc., has announced the removal of his company to its new quarters in the General Motors Building, 1775 Broadway, New York City. According to Mr. Nelson approximately 50 stations in the United States and 3 stations in Canada are regularly using the recorded program service of his company.

An entire additional floor has been added to the New York plant of the Polymet Manufacturing Corporation located at 829 East 134th street. Officials of the company state that announcements will soon be made of additions to their manufacturing plants at Winsted, Conn., and Easton, Pa.

The Van Horne Tube Company has opened an office and warehouse at 108 West Lake St., Chicago. From this point all adjoining territory will be served. The new facilities will make possible 24-hour service to all the important markets of the United States.

Distributors Appointed

HY-VAC RADIO TUBE CORPORATION, 86 Shipman Street, Newark, N. J., has appointed as Pacific Coast sales representatives the James P. Hermans Company, 585 Mission St., San Francisco, Calif., and the Marshank Sales Company, 224 East 16th St., Los Angeles, Calif. W. A. Bittner, 405 Penn Ave., Pittsburgh, Pa., and the Halperin Distributing Company, 5 West 19th St., New York, have also been appointed.

STEINITE RADIO COMPANY, Fort Wayne, Indiana, announces that the Nott-Atwater Company, Spokane, Wash., have been appointed Steinite distributors in that territory.

CECO MANUFACTURING COMPANY, Inc., Providence, R. I., announces the appointment of two Chicago distributors: the Sheridan Auto Supply Company, 3921 Sheridan Road, and the Siegel Electrical Supply Company, 130 North Clinton St.

VAN HORNE TUBE COMPANY, Franklin, Ohio, has recently selected several firms to represent the company. They are: R. R. Bean in the Pacific Northwest and in British Columbia; Gerber Sales Company, 94 Portland St., Boston, Mass., for the New England States; Gil Studeker covers northern Illinois, northern Indiana, and eastern Wisconsin; The F. T. Reuter Company, Kansas City, serves the trade in Missouri, Iowa, Arkansas, Oklahoma, Texas, Louisiana, and western Tennessee; J. D. Palmerlee for the entire state of Michigan; Paul Douden, of Denver, for Wyoming and Utah, and A. W. Marshall, of Louisville, for Kentucky. Other new distributors for this company are: The Johnson Electric Supply Company, The Campbell Service Company, The Southern Ohio Radio Corporation, and the C. & D. Auto Supply & Radio Corporation. These companies are also distributors of nationally advertised radio equipment and are all located in Cincinnati, Ohio.

B. W. SMITH, INC., Cleveland distributors of Edison radios, phonographs, and records, announces a new division of this company. It is the Edi-Radio Mart, located at 622 Broadway Ave. in Cincinnati. T. R. Boring will be in charge.

THE STATES OF Maine and New Hampshire have been added to the territory covered by Gross-Brennan, Inc., eastern district distributors of Stromberg-Carlson receivers. They now cover Metropolitan New York, New Jersey, and all of New England with the exception of Vermont.

THE FOLLOWING representatives for General Amplifiers have recently been appointed: Walter W. Boes, 622 Broadway, Cincinnati, Ohio, who will cover the territory of southern Ohio and northern Kentucky; C. J. Spencer, 29 Stewart St., Detroit, Mich., who will handle this line in and around Detroit; V. A. Hendrickson, c/o Martin-Copeland Company, 37 Maiden Lane, New York City, who will cover the territory of Metropolitan New York, Philadelphia, New Jersey, and southern Connecticut.

THE RADIO DIVISION of the Gulbransen Company, of Chicago, has appointed five new jobbers in seven of the larger distribution centers of the country: Braiterman Fedder Company, Baltimore;

Financial Notes

The regular quarterly dividend of 1 1/2 per cent. on the preferred stock of the Sparks-Withington Company was declared payable September 16th. A dividend of 25 cents per share on the new common stock, payable September 30, was also declared.

According to figures supplied by A. T. Murray, president, the American Bosch Magneto Corporation, earnings for the first six months of this year were \$1.80 a share as against 50¢ the previous year.

The Grigsby-Grunow Company and subsidiaries report a net earnings before deducting Federal taxes of \$5,679,341 for the year ending May 31, equivalent to \$13 a share on the 437,040 shares of common stock outstanding. Net profit available for common dividends after deducting taxes and non-recurring charges, amounted to \$4,915,932. Net sales for the twelve months totaled \$49,318,668, gross profits on sales being \$9,004,551. The company announced that almost 800,000 receivers were built.

George Byers and Sons Co., Columbus, Ohio; Colonial Electric Supply Company, Philadelphia; North Coast Electric Company, of Portland, Oregon, Seattle, and Tacoma, Washington; and Smith-Hassler-Sturm Company, Indianapolis.

TWO ADDITIONAL distributors this year in the Hawaiian Islands bring the total list of Bosch radio distributors in the Pacific Coast Division to fourteen. The two Hawaiian distributors are Moses Stationery Co., Ltd., Hilo, T. H., and Tevos and Tevos and Joaquin Co., Ltd., Honolulu, T. H.

SPEED TUBE sales for the western district will be in the hands of C. M. McIntosh, it has been announced from the offices of Cable Radio Tube Corporation. In the southern California territory, Barrie C. Bloeden, of 1321 Maple Ave., Los Angeles, has been appointed and his company will operate under the name of Speed Sales Company. In northern California, the Monarch Sales Company, 1268 Mission St., San Francisco, has been named Speed representative. For Washington, Oregon, and Idaho, the A. S. Detsch Company, Security Bldg., Portland, has been selected. All these sales organizations and the Denver representative, the C. M. McIntosh Company, now are directly under the supervision of Mr. McIntosh.

ANNOUNCEMENT was made on October 10 of the appointment of H. M. Tower Corporation, of Boston and New Haven, as wholesale distributors of Bosch Radio in Vermont and western Massachusetts. Charles J. Parker, of Minneapolis, Minn., has opened a distributing house in that city for the distribution of Bosch Radio.

Contest Winners Receive Stromberg-Carlson Radios as Prize

Herbert A. Brennan, of Gross-Brennan, Inc., distributors of Stromberg-Carlson receivers, presents prizes to winners of a contest in which participants were asked to state in twenty words why they would like to own a Stromberg set. Winners are (left to right): Frank A. Walsh, first prize; William J. C. Belbey, second prize; and Mrs. A. Kunow, third prize.



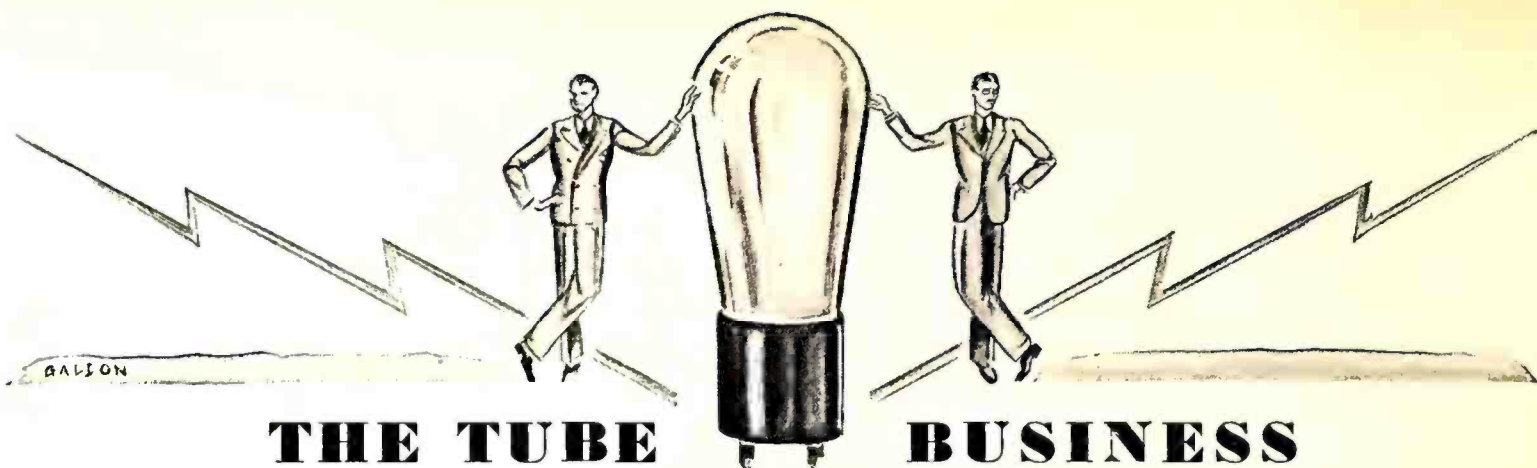

THE TUBE BUSINESS

FINANCIAL NOTES

CECO OFFERS rights to its shareholders, one share for every five now held. For the first eight months of the year, Ken-Rad reported net earnings of \$242,471 after deducting all charges but taxes. This compares with \$123,127 for the same period of last year. Earnings are estimated to be \$4 a share for the year. CeCo's net income for September was \$88,147 after deducting charges, royalties, and taxes. Public offering is to be made of 49,000 shares of no par value stock of the Tungsten Electric Corporation. This company was organized to acquire Callite Products Co., Inc., Independent Contact Manufacturing Co., Inc., International Wire Co., Inc., and Precision Metal Products Co., manufacturers of tungsten and molybdenum products for the electrical equipment industry.

The National Union Radio Corporation has acquired the assets of the Northern Manufacturing Company, makers of Marathon and other tubes. An exchange of stock of the two companies is made on the basis of $\frac{2}{3}$ share of National Union for one share of Northern. The exchange involves 70,000 shares of Northern stock.

SALES NOTES

SEPTEMBER DEFOREST sales set an all time record, 37 per cent. above August. Gold Seal reports unfilled orders amounting to six million dollars. Marvin reports a single order for one million tubes, a contract amounting to \$800,000. Perryman sales in September were up 185 per cent. and in nine months were up 202 per cent. from one year ago. CeCo sales for August aggregated \$302,151 or 196 per cent. above one year ago. Cable's (Speed) August sales were three times as great as those for the same period last year. In September the company had orders on hand for 2,000,000 tubes.

TUBE SHORTAGE IN OHIO

IN SEPTEMBER a shortage of tubes was reported in the Cleveland district. Jobbers in the Ohio city reported they were unable to get a sufficient supply of tubes to serve their clientele.

MAKING 25,000 TUBES A DAY

SIX MARVIN plants which were running at 18,000 tubes a day in October will be speeded up to 25,000 a day in November to fill contracts on hand. This is sufficient proof, according to F. A. LaBaw, sales manager of Marvin, that Marvin is following the correct policy. Manufacturers who make arrangements with set makers are likely to find themselves in hot



F. A. LaBaw

The Customer Depends on the Serviceman

BY L. P. NAYLOR

Sales Manager, Arcturus Radio Tube Co.



L. P. Naylor

MY FIRST THOUGHT in regard to the serviceman and his relation to the sale of tubes is that he is a hindrance to tube manufacturers. This does not mean that he cannot prove to be just the opposite and in even greater proportions. Perhaps this is the result of poor tube

construction and habit on the part of the serviceman.

The average serviceman makes his call with the idea that the fault is with one or more of the tubes. He believes the set is perfect because he has either tested it before the sale or because he has tested a good number of similar sets sold by his employer. He overlooks the fact that he likewise tests a large percentage of the tubes. He is too ready to believe the tube will not stand up—probably as a result of past experience with inferior tubes.

When the serviceman tells the customer that the reason for poor reception is tubes, his personal opinion, the likes and dislikes or preference for the tube of a certain manufacturer plays a big part.

If the serviceman will change his attitude and be fair with respect to present-day tubes, much will be gained.

The serviceman's intimate contact within the home of the customer places him in a position to have his actions mean more than will any other contact.

Radio set owners have a right to depend on the serviceman. What he does and says will govern the entire case.

water when "in times of stress they are confronted with binding alliances which have to receive first consideration."

VALUE OF TIME ON THE AIR

DOES TIME on the air pay the tube manufacturer? H. H. Steinle, of the Triad Manufacturing Company, believes it does. "We believe that a considerable percentage of our present business is due largely to the reaction to our radio programs. They serve as a means of acquainting the prospective buyer with our product. The next logical step is for him to visit the dealer's store." Mr. Steinle backs up the radio advertising with aggressive newspaper advertising in the leading cities.

AVERAGE TUBE PRICES

AVERAGE RETAIL PRICES of radio tubes have decreased and then increased according to the following table prepared by

Chester Braselton, president of Arcturus. In 1922 the average price per tube was \$6; 1923 \$3.77; 1924 \$3; 1925 \$2.40; 1926 \$1.93; 1927 \$1.63; 1928 \$2.19.

PRODUCTION NOTES

THE MUNDER ELECTRICAL CO., Springfield, Mass., has increased production to 6000 tubes a day. This firm makes Vox tubes and tubes for the Radio Retailers' Ass'n. DeForest is operating two plants with a total floor space of 150,000 square feet, has over 2000 employees, and passes for shipment over 25,000 tubes a day. Cable is operating four plants which do nothing but supply raw materials for Speed tubes. The CeCo factory operates 23 hours a day; one hour in the early morning is allowed for the plant to cool off. Hy-Vac has moved into a newly purchased building in Newark. It has about 225,000 square feet of floor space. The September production aim of this company was 15,000 tubes per day. George Duff, president, Gustave Binder, vice president and treasurer, and J. Franklin Dorsey, secretary, are Hy-Vac officers.

THE NATIONAL UNION MERGER

AN OFFICIAL of one of the constituent companies making up the National Union Radio Corporation had the following to say regarding the amalgamation and what it will mean to the individual companies:

"This is not only a business merger; it is at the same time, a merger of the business brains, merchandising genius, and the engineering talents and experience of these four big organizations, together with a merger of their finances. All of the advantages accruing from this enhancement of facilities will be reflected directly in the product itself.

"Added to this are the advantages which result from the right to utilize the patents of the Radio Corporation of America, General Electric Company, and Westinghouse Electric and Manufacturing Company plus all that is implied by the two-million dollar investment by the Radio Corporation of America in the new company. It will be readily seen that the clients of the divisions of the National Union Radio Corporation are happily connected with one of the largest and most progressive units in the entire tube industry."

HARRY HOLMES RESIGNS

EFFECTIVE OCTOBER 14, Harry C. Holmes resigned as director of sales of the De Forest Radio Company after an association with the company since its reorganization in June, 1928. At the time this was written (October 20), Mr. Holmes had formed no other connection in the radio business.



H. C. Holmes

Tuned BAND-FILTER

Flat-Top, Straight-Side
10-Kilocycle Selectivity

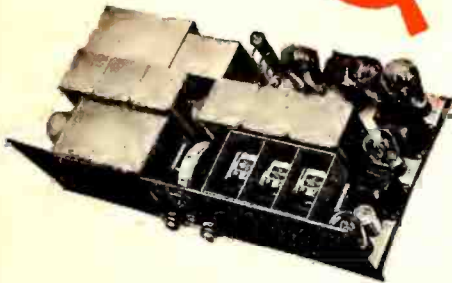

A famous feature exclusive with Hammarlund Receivers for two years.

Gives perfect 10-kilocycle tuning, without cutting sidebands.

Reduces background noises. Improves tone.

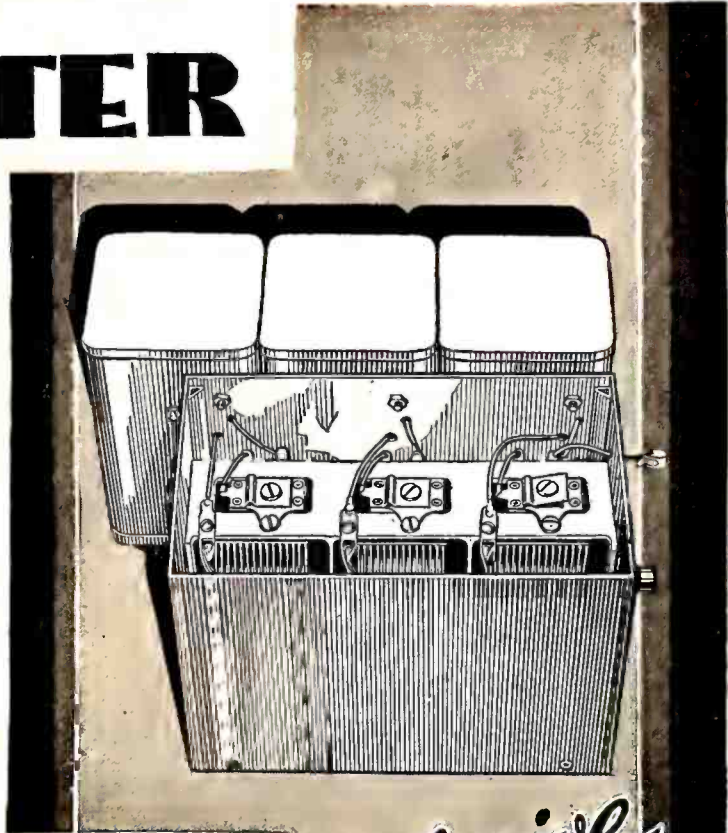

Exclusive

NEVER before, outside of special laboratory models, has there been available to radio constructors such a receiver as the new "HiQ-30."

Its extraordinary features are so far in advance of even previous "HiQ" Models that the loyal army of Hammarlund enthusiasts throughout the world will welcome the "HiQ-30" with nothing short of amazement.

A masterpiece mechanically and electrically, with extraordinary beauty as well. No miscellaneous collection of parts—but each component specially built for the characteristics of the circuit and everything to the last screw supplied by the factory.

Perfect selectivity—range limited only by atmospheric conditions—deafening power under velvet control—tone that thrills the music critic—one-dial operation—uses any length antenna—push-pull '45 audio amplifier—permanent phonograph connection—choice of speakers and cabinets, including phono-radio combinations.

Build the "HiQ-30" yourself or we'll recommend a local custom-radio builder to assemble it for you.

Get the "HiQ-30" story Now. Mail coupon for 48-page Manual—a wonderful guide book for constructors of modern receivers.

Completely Wired
Factory-Built Units

Including Three-Stage Tuned Band Filter—Three-Stage Tuned Screen-Grid Amplifier—Special Power Pack—Six Tuned Circuits—individually and collectively shielded.

The most flexible—the most scientifically perfect—the greatest performing radio of all time.

HAMMARLUND-ROBERTS, INC.

424-438 W. 33rd St., New York



BLACKSTONE
One of nine magnificent "HiQ-30" Special Consoles available from the factory.



WINDSOR
A radio-phonograph combination of rare excellence and distinctive beauty.

Hammarlund
Custom-Built
RADIO

Mail Coupon and 25c. for "HiQ-30"
HAMMARLUND-ROBERTS, INC., Dept. RB-12
Enclosed 25c (stamps or coin) for 48-page
"HiQ-30" Manual.

Name.....

Address.....



MANUAL
424-438 W. 33rd St.
New York

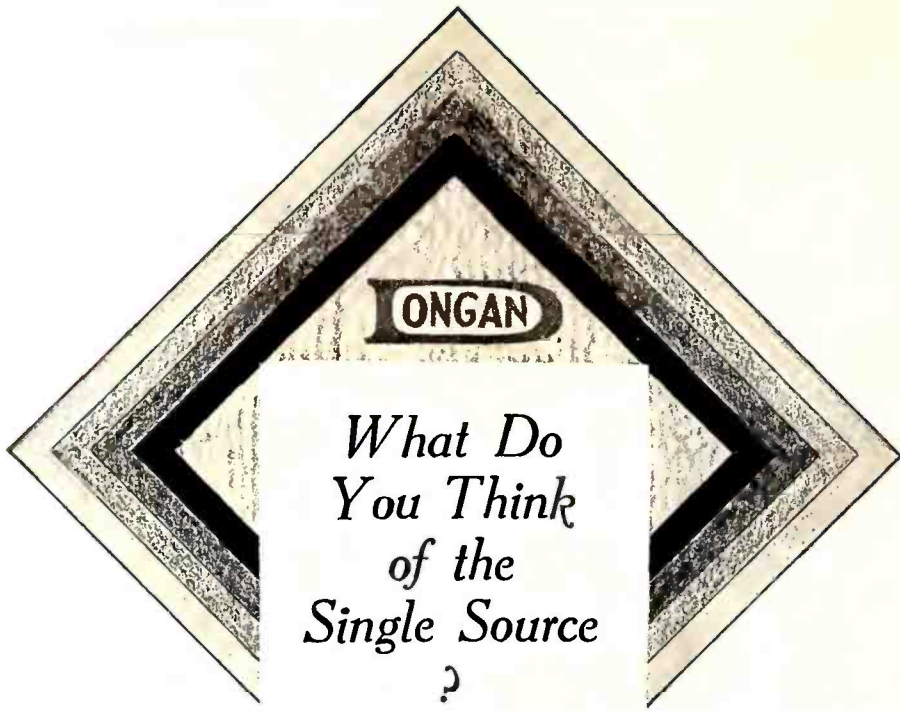

What Do
You Think
of the
Single Source
?

DANGEROUS? All your eggs in one basket? Or have you found from experience that, like everything else, it depends upon just who the Single Source of Supply happens to be.

Any radio manufacturer who has a season's contract with Dongan has a season's insurance—on a quality product, delivered as promised. There will be no halts, no delays in the production line, nor rejected sets nor amplifiers because of an inferior run of transformers.

Year after year the list of those whom Dongan serves as a Transformer Source, is augmented by a few more of the larger and better manufacturers. Those of you who seek such a satisfactory source for the coming season are invited to make use of our Engineering facilities for experimental work—now.

Transformers Chokes Condenser Units

Complete Parts for construction of Amplifiers for theaters, dance halls or public address systems

Dongan Electric Manufacturing Co.

2991-3001
Franklin Street



Detroit
Michigan

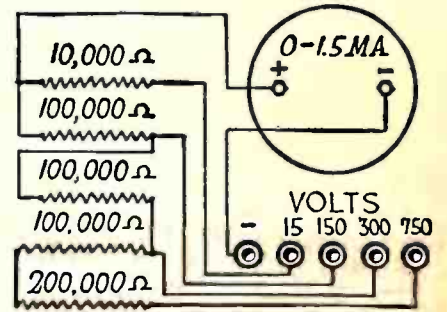

A Voltage Multiplier

The Super Akra-Ohm wire-wound Resistor is especially adapted for use as a Voltage Multiplier as shown in the above diagram. It is carefully designed to insure an accuracy of 1% and a constant permanency of calibration. Its use is also highly recommended for Laboratory Standards, High Voltage Regulators, Telephone Equipment, and Television Amplifiers and Grid and Plate Resistors, etc.

BULLETIN 62

contains the first complete chart for the use of accurate resistors with microammeters and milliammeters. Send for your copy today. There is no obligation.



MODEL 489 D. C. PORTABLE THREE-RANGE VOLTMETER

750 - 250 - 10 Volts
1000 Ohms per Volt Resistance

A STURDY, miniature instrument, suitable for home or laboratory use—popular because of its small size and unusual electrical characteristics. A truly professional instrument, with all the niceties of design and construction which make a "Weston" so desirable.

Solid black bakelite case, convenient pin jacks, and test cables equipped with pin terminals for insertion in the jacks. Reasonably priced.

Weston Electrical Instrument Corp.
604 Frelinghuysen Ave., Newark, N. J.

WESTON RADIO INSTRUMENTS

Fulco RADIO COVERS



"FULCO" covers are used by those dealers who realize the importance of making deliveries in perfect condition — without scratches or mars. For they know that complaints mean dissatisfied customers and loss of business.
"FULCO" covers are a real service feature that helps sales and holds trade. Substantially constructed, heavily padded, box-shaped, providing perfect protection. Give us the dimensions of radios handled and let us quote special prices on your individual needs. Write our nearest house.

Fulton Bag & Cotton Mills

Manufacturers Since 1870
ATLANTA · NEW ORLEANS · DALLAS · ST. LOUIS
MINNEAPOLIS · BROOKLYN · KAN. CITY · KAN.

ON AND OFF
IN A JIFFY

PRESTIGE FOR SALES-VOLUME

The Webster Electric Pick-up is universally used in homes and theatres because of its outstanding quality and tone reproducing ability. Its satisfactory record in the past makes it the world's standard of the present. No competitive equipment offers such a group of original and distinctive features. No other pick-up is so looked to for the introduction of latest engineering developments.

The Webster record of performance and sales is of interest to every dealer. The Webster Electric Pick-up enjoys buyer-preference because its rich full-toned music is so appealingly lifelike. It reproduces all the notes of the musical scale, from the highest to the lowest frequencies, with satisfying fidelity and volume.

The new Webster Pick-up is available in two models, both for either battery-operated or A.C. sets. Both models are packed in attractive self-selling cartons. If your jobber has not stocked the Webster, order direct—now!

WEBSTER ELECTRIC COMPANY Racine, Wisconsin

SPECIAL FEATURES

Webster low-inertia stylus bearing with all-metal pivoting action. Small, light-weight, perfectly balanced head.

Highest grade Cobalt magnet of greatest density.

Shock-absorbing arm bearing with pivot at base—exclusively Webster.

Head turnable for needle-insertion.

Volume control in base.

Weighted base.

Cord completely concealed—all bearings free from chatter.

Can be used for standard or talking picture records.

The New Webster Model 2-B includes Pick-up head, separate volume control, and necessary adapters.



The new Webster Model 2-A includes Pick-up head, supporting arm, built-in volume control, and necessary adapters.



The Webster Electric Theatre Pick-up is for use with 16" records at 33 1/3 R.P.M. Adjustable counterbalance permits correct control of weight on record. Base may be mounted with rubber bands to absorb vibration. With standard or low impedance head.

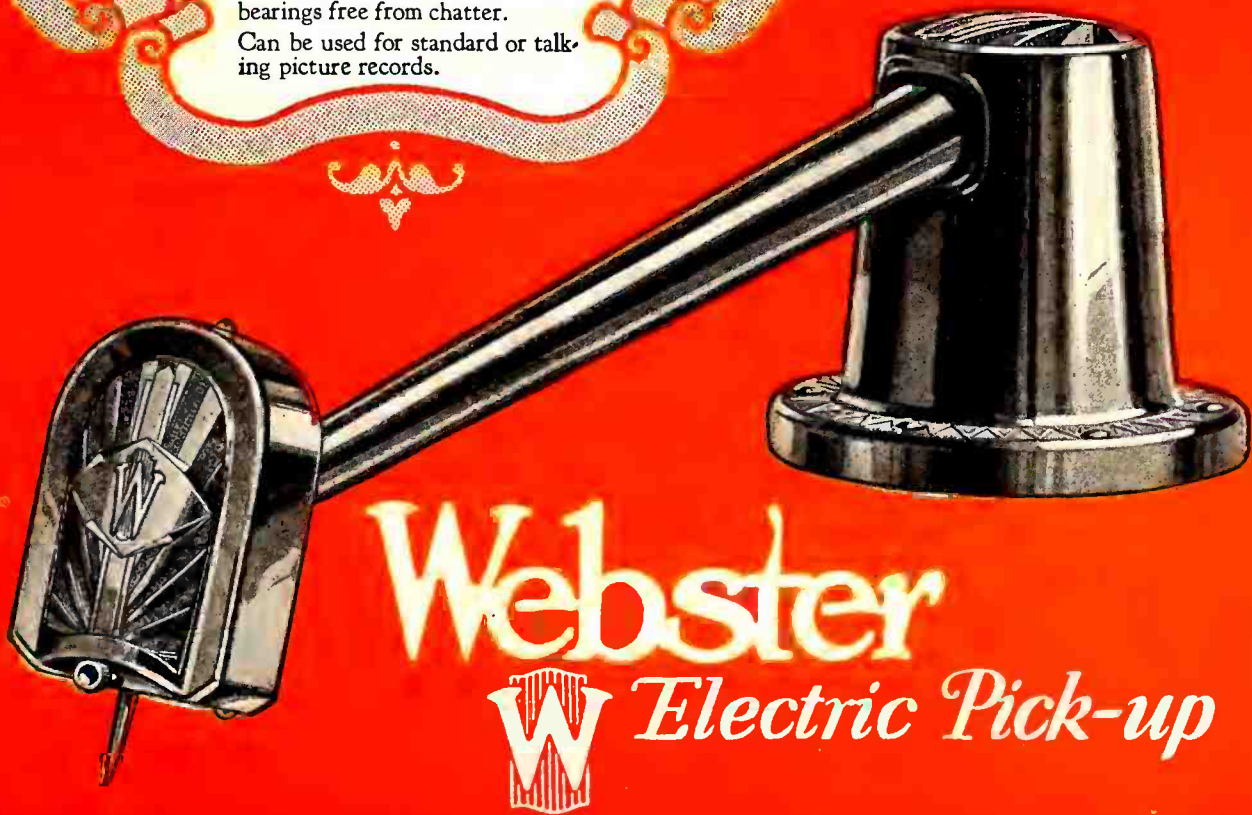

Webster

W Electric Pick-up



Carton of four Eveready Raytheon B-H Tubes

WHEN TUBE REPLACEMENTS ARE NECESSARY IN "B" ELIMINATORS

EVEREADY RAYTHEON B-H

MOST "B" power units are designed for the B-H tube . . . the original gaseous rectifying tube. Millions of such units have been sold in the past few years. When tube replacements are necessary, a new Eveready Raytheon B-H Tube will give the greatest satisfaction. Tell your customers what a tremendous improvement in reception a new rectifying tube will make.

Eveready Raytheon B-H Tubes come in handy packages of four tubes each. Always keep at least one full carton on display. The market for these tubes is enormous!

NATIONAL CARBON CO., Inc.
 General Offices: New York, N. Y.
 Branches: Chicago Kansas City
 New York San Francisco
 Unit of UCC and Carbon Union Carbide Corporation



Trade-marks

TYPE 360 TEST OSCILLATOR



One of the new test oscillators for the radio service laboratory is now ready. It will deliver a modulated radio-frequency voltage at any point in the broadcast band (500 to 1500 kilocycles) and at 175 and 180 kilocycles. The tuning control is calibrated with an accuracy of 2 per cent.

The Type 360 Test Oscillator is intended to be used for neutralizing, ganging, and tuning of the radio-frequency stages in a receiver, and it is fitted with an output voltmeter for indicating the best adjustment. This voltmeter is of the copper-oxide-rectifier type, and by means of a switch it may be connected across a 4000-ohm load or across the dynamic speaker of the receiver when making tests.

Price \$110.00

GENERAL RADIO COMPANY

30 State Street

Cambridge, Massachusetts

Analyze Set Troubles Accurately & Quickly

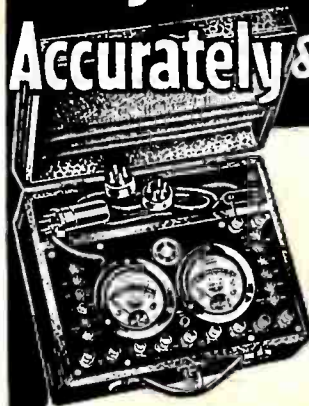

Jewell Radio Set Analyzers revolutionize radio servicing. They service screen grid sets, test tubes, and test receivers in service, stage by stage. Binding posts make all instruments available for special tests. Data and instructions

simplify servicing, and make it accurate. Every serviceman should have a Jewell. For sale by jobbers everywhere.

FREE to SERVICEMEN

New 64-page booklet containing accurate data on sets of 38 leading manufacturers—139 sets in all—now furnished free to servicemen.



Jewell Electrical Instrument Company
 1642-H Walnut Street, Chicago, Illinois

Send your booklet, "Instructions for Servicing Radio Receivers," also literature describing Jewell Radio Service Instruments.

Name.....

Address.....

AEROVOX BUILT BETTER CONDENSERS AND RESISTORS

Pyrohm Resistors Accurate — Unchanging

REDUCED sensitivity, low volume, distortion and poor tone quality are the inevitable results of using inaccurate resistors which do not maintain their proper resistance values.

To be assured of satisfactory operation in power supply units and power amplifiers, be sure to specify and use—Aerovox Pyrohm resistors of the proper resistance values and current carrying capacities.

These units are made of the best grade of resistance wire wound on a refractory tube, and protected by a porcelain enamel against moisture, oxidation and mechanical injury.

Send for Catalog

Complete specifications of all Aerovox Pyrohm resistors are contained in a complete catalog which will be sent free of charge on request.

The Research Worker

contains, each month, valuable information on radio design. It will be sent free on request.

AEROVOX WIRELESS CORP.
 76½ Washington St., Bklyn, N. Y.
 PRODUCTS THAT ENDURE

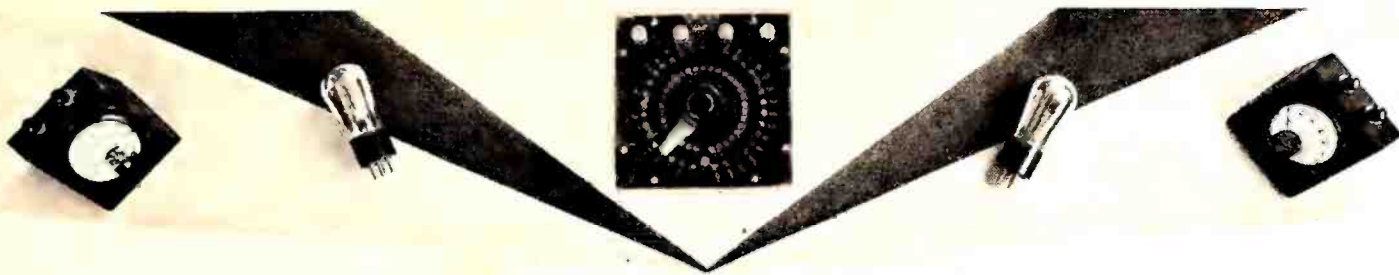

STRAYS FROM THE LABORATORY

Regarding Synchronized Stations

FROM TIME TO TIME the public press is assailed by someone who has a newly discovered scheme for doubling up on the ether by transmitting the same audio-frequency program over several stations which are synchronized to the same r.f. carrier. Such a system is offered as a panacea for those who do not want to pick up the same program at more than one point on the dial—as a panacea for those who wish to decrease the number of stations now on the air, and as a panacea for those who want to increase the number of programs now on the air.

Since there is such recurrent interest and speculation on this matter of putting several stations on the same frequency, it seems worth while to review briefly a paper read in March, 1929, before the Wireless Section of the Institution of Electrical Engineers (London) by Captain P. P. Eckersley and A. B. Howe. Until recently Captain Eckersley was chief engineer of the British Broadcasting Company, and he is well known among all serious and well-informed radio engineers.

In 1926, 1927, and 1928, four British stations operating on low power and transmitting the same program were synchronized to within 100 to 200 parts in a million.

Consider first the unmodulated carriers of two stations. If the stations were situated close enough so that either carrier could be heard if the other were turned off, an interference pattern would be set up. Under these conditions a listener in a locality where the carriers come to him in phase will receive signals which may be twice as strong as those which could be produced by either station, and a listener in a locality where the carriers are out of phase may receive nothing at all.

Now if the carriers are modulated with the same single audio-frequency tone, listeners near either station will receive the modulation undistorted, but listeners midway between the two stations will receive "mush." In other words, turning on the second of two such stations restricts and reduces the service area of the other.

Now suppose the stations send out the same program consisting of tones situated at various parts of the audio-frequency spectrum. Because these side frequencies may not arrive at a listener's receiver in phase, even though the carriers are in phase, the listener will get distorted signals.

To test these and other possibilities, two stations, G5BG and G5RR, were tuned to 610 kc. and maintained there by transmitting a synchronizing signal of 305 kc.

from a third station. This signal was picked up by both stations, doubled, and used to drive the two transmitters. They were supplied with the same program by a 38-mile wire line which connected them. A portable field strength measuring set and a standard receiver were transported to

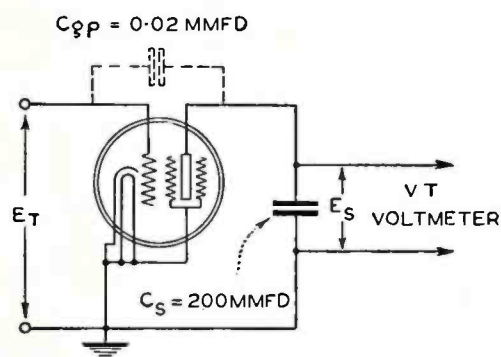

various localities in the field of the two stations.

All types of distortion discussed above were found; in addition it was learned that if one station were five times stronger than the other, the program of the first would be received properly and without distortion. If one station differed by five cycles in carrier frequency from the other, it would be necessary that the first station be ten times stronger than the second at a given locality in order to receive an undistorted signal. If the two stations transmitted different programs but on exactly similar carrier frequencies, the strength of one would have to be from 100 to 200 times stronger than the other in order to receive undistorted programs.

The difficulty in using the same carrier frequency for several programs, or for the same program, comes from the fact that the direct ray from the transmitter

is supplemented by the indirect ray reflected from the Heaviside layer. At locations remote from the transmitter the latter is the more important; it causes fading and distortion. It seems wise to use antennas which transmit poorly toward the sky and which confine their radiation more nearly to the ground wave. Such radiators are high vertical antennas.

Captain Eckersley states that for large distances between stations, it is better to use low frequencies; for short distances it is better to use higher carrier frequencies. This is due to the fact that the direct ray falls off more with distance as the wavelength is decreased, while the indirect radiation seems to be more or less independent of the distance. Another interesting result of the author's experiments leads to the statement that when 6 or 7 stations share the same frequency, their service areas are not affected by the addition of other stations.

The problem seems to resolve itself into several phases: (1) to provide accurate synchronism between stations either by transmitting a standard radio-frequency signal from some centrally located station, or by means of land lines; (2) to restrict the radiation as much as possible to the ground wave; and (3) to choose properly the location and power of the stations sharing the common frequency.

Measuring Screen-Grid Capacity

Measurement of the extremely small capacity existing between plate and grid in a screen-grid tube is a difficult problem. Comparative measurements are not difficult to make by putting the tubes across tuned circuits and measuring the change in frequency, but to get the capacity in exact units involves a standard of the order of 0.02 mfd.

In *Experimental Wireless* (England), June, 1929, the following method is put forth as a way out of the difficulty. It involves putting another and larger condenser in series with the desired capacity, and measuring the voltage across this large capacity when a known voltage is put across the two capacities in series. Thus in Fig. 1 the voltage is shared by the tube capacity and the large known capacity, which is about 10^4 times as great as the grid-plate capacity whose value is desired.

A potential at 1500 kc. of about 600 volts was generated in a tuned circuit. This voltage was measured by means of an electrostatic voltmeter and applied to the two condensers in series. The capacity is found from

$$C_{g-p} = C_s \frac{E_c}{E_s} \text{ since } C_s \text{ is about } 10^4 \text{ times } C_{g-p}.$$

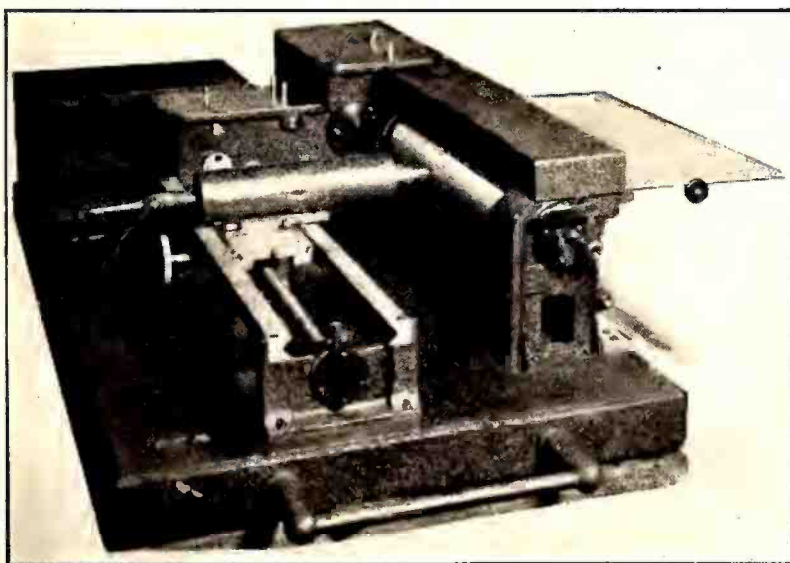

The apparatus pictured above is the new high-speed facsimile receiver developed by R.C.A. for transatlantic service.

IN THE RADIO MARKETPLACE

News, Useful Data, and Information on the Offerings of the Manufacturer

Sonora Screen-Grid Set

SONORA PHONOGRAPH COMPANY, INC.: The Sonora Model A-31 Screen-Grid Low-boy receiver lists at \$149.50. The set is of unit construction, being composed of three separate units; the r.f. amplifier and detector, the a. f. amplifier, and the power supply with an electrodynamic loud speaker. Any one of the three units may be removed readily for servicing. The set uses three screen-grid tubes and power



detector followed by a single stage of a.f. amplification and a push-pull power amplifier with two 245-type tubes.

Zenith Model 53

ZENITH RADIO CORPORATION: This receiver uses a nine-tube chassis with the following features: automatic tuning, screen-grid tubes, double push-pull amplification, automatic volume control, and a large size electrodynamic loud speaker. The receiver lists at \$275.

Jack Horner Speakers

OPERADIO MANUFACTURING COMPANY: Believing that the next big step in radio will be remote control, this company is manufacturing an electrodynamic loud speaker in an artistic baffle designed to be hung from the molding. It is known as the Jack Horner model and it has an effective baffle length of 40 inches. It is made for operation on 110 volts 25-40 cycle, 110 volts 50-60 cycle, and 110 volt d.c.

Temple D. C. Receiver

TEMPLE CORPORATION: To meet the demand for a receiver designed for operation on 110 volts d.c. this company has produced a set using six 112A's and four 171A's. It uses a fourteen-inch electrodynamic loud speaker and is available in two different models.

New Connector Plug

NATIONAL COMPANY: A semi-soft rubber cable connector plug has been developed to be used as simple and effective method of connecting the chassis of an electrodynamic loud speaker field to a power pack.

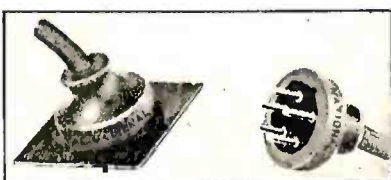

Webster Electric Pick-up

WEBSTER ELECTRIC COMPANY: The new Webster pick-ups have the following features: low-inertia stylus bearing utilizing an all-metal pivoting action; small carefully balanced pick-up bead giving a weight on the record of only 4½ ounces; Cobalt steel magnet; shock-absorbing arm bearing with pivot at base; volume control incorporated in base. The pick-up is available in various models either with or without the tone arm or volume control. A pick-up designed especially for use with the Victor Radio, Model 32, lists at \$19.50.

New Tube Socket Designed

CINCH MANUFACTURING CORPORATION: This company has designed a series of radio tube sockets. The sockets are constructed so as to give good contact and with accessible lugs for soldering. For years this company has been manufacturing fasteners for automobile manufacturers.

New Thermatrol Products

THERMATROL MANUFACTURING COMPANY: The new Filtrol No. 460 is designed to eliminate interference that reaches a radio receiver through the a.c. lines. The unit contains a combination of inductance and capacity, and is connected between the light socket and the radio receiver. The Filtrol No. 458 is designed for connection directly to the apparatus producing interference. The Thermatron heavy-duty line voltage control No. 210 is designed to absorb excess line voltage. The device contains four separate outlets to take care of all usual line voltage variations.

Capehart Automatic Phonograph

CAPEHART AUTOMATIC PHONOGRAPH CORPORATION: The Capehart Club Model Orchestrope, No. 28-F, combines an automatic phonograph with a three-stage power amplifier and an electrodynamic loud speaker. It will play twenty-eight records automatically on both sides



at an operating cost of approximately two cents per hour (ten cents per kwh.). The dimensions of the cabinet are: height 41½ inches, width 45 inches, and depth 23½ inches. The instrument is shipped as a complete unit and the tubes are packed in a box which is placed in the bottom of the cabinet.

Portable Phonograph

Q. R. S. De Vry Corporation: Five different types of portable phonographs are being made by this company. The Model 15 lists at \$15, the Model 20 at \$20, the Model 25A at \$25, the Model 50 at \$50, and the Model 375 at \$37.50. Some models are designed for operation from the a.c. line and others derive their power from dry-cell batteries contained in the cabinet.

Utona Loud Speakers

AMERICAN RADIO PRODUCTS CORPORATION: The electrodynamic loud speakers manufactured by this company are available in various models for either a.c. or d.c. operation.

RCA Theremin

RADIO-VICTOR CORPORATION OF AMERICA: The Theremin is a musical instrument being manufactured under an option on the patent held by the inventor, Professor Leon Theremin. The instrument is operated by moving the hands relative to the loop bar which controls the volume and the vertical rod which controls the pitch. The device is actually a beat-frequency oscillator whose output is controlled by the



capacity coupling between the hands of the operator and the looped bar and the vertical rod.

New Microphone

RADIO RECEPTOR COMPANY: This company announces a new line of microphones for public-address and other sound-reproduction purposes. Although designed particularly for use with a Powerizer sound-amplifying system, they may be used satisfactorily with any well-designed amplifier. Three different types are made, a 3½-inch, a 6-inch, and a hand microphone.

Utah Loud Speakers

UTAH RADIO PRODUCTS COMPANY: The Model 66-A Stadium electrodynamic loud speaker was designed for 110-volt a.c. operation. The overall diameter is 12½ inches, the cone diameter being 10½ inches. It is equipped with a full-wave high-voltage rectifier which operates directly from the a.c. line without any step-down transformers. The loud speaker can be used on either 25 or 60 cycles.

The Grebe Synchrophase

A. H. GREBE AND COMPANY: Features of the new Grebe receivers are three screen-grid tubes, band-pass filters, push-pull amplification, large diameter electrodynamic loud speaker, and automatic line voltage control. The set uses six tuning condensers and contains a special phonograph pick-up input transformer so that modern high-quality low-impedance pick-up units may be used.

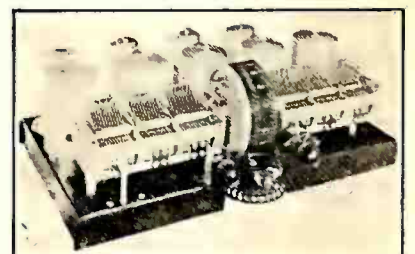

Stewart-Warner Phono-Radio

STEWART-WARNER CORPORATION: The new phonograph-radio combination manufactured by this company is contained in a cabinet of excellent construction and uses a screen-grid receiver in combination with a Gordon phonograph motor. The cabinet has sliding doors and a file for twenty records. List price: \$285.75.

New Freed Receiver

FREED-EISEMANN RADIO CORPORATION: The new Model NR-90 employs an automatic tuning device which permits automatic selection of ten favorite stations. It uses four screen-grid tubes, three as r.f. amplifiers and one as a detector. List price: \$182.50.

New Carryola Products

ALLEN-HOUGH CARRYOLA COMPANY: The combination radio-phonograph cabinet, Model 175, contains an electric motor and turntable together with a Webster pick-up. Space is provided for the installation of any standard radio receiver and loud speaker. The Rotrola is a small portable phonograph designed for 60-cycle a.c. operation.

New Crosley Model

CROSLY RADIO CORPORATION: The Crosley Model 33-S which was announced recently is a seven-tube screen-grid receiver housed in a

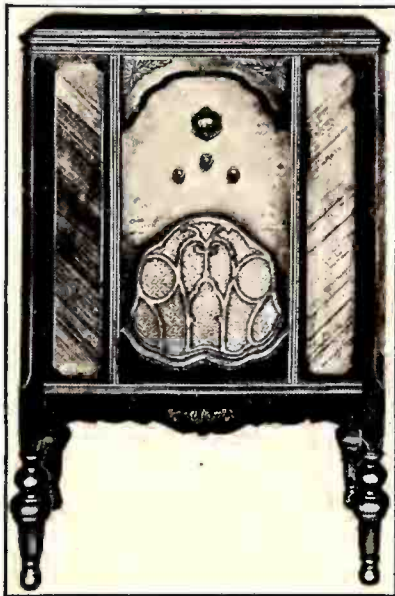

console cabinet. The cabinet is of walnut veneer. A feature of the receiver is the triple-range control switch to give distant, near-by, and local reception.

New Portable Phonograph

STEVENS MANUFACTURING CORPORATION: The new Stevens portable electric phonographs are made in two models. The type AC is designed for operation from a light socket. The type B is operated from three standard dry-cell batteries placed in a compartment in the case. The d.c. model is designed especially for portable use and it may be played anywhere at any time. Both models are equipped with a mechanical reproducer but an electrical reproducer can, of course, be used.

Sentinel Receivers

SENTINEL MANUFACTURING COMPANY: The Model 666-C is a nine-tube receiver with four screen-grid tubes, two 227's, and two type 245's. It is a phonograph-radio combination and uses a United pick-up and United electric motor. The list price is \$149.50. The Model 666 is similar to the 666-C except that it does not contain a phonograph, being simply a console radio receiver. List price \$99.50.

Gulbransen's New Set

GULBRANSEN COMPANY: The Gulbransen combination radio-phonograph, Model 200, combines all the features of the Gulbransen nine-in-line screen-grid radio set, and has in addition a phonograph compartment in the top. It is equipped with a ten-inch electrodynamic loud speaker and uses five 226's, one 224, two 245's, and one 280. Price: \$235.00.



New Victor Receiver

RADIO-VICTOR CORPORATION OF AMERICA: The Victor receiver is now available in a new cabinet design. It is known as the Model 952. Price: \$215.00.

A. C. Short Wave Set

PILOT RADIO AND TUBE CORPORATION: A new screen-grid short-wave receiver known as the A.C. Super-Wasp has been designed. It uses a special 227-type detector tube preceded by a screen-grid tube. The wavelength range is 14 to 200 meters, although extra coils can be obtained to extend the range to 500 meters.

Sterling Radio Receivers

STERLING MANUFACTURING COMPANY: The Sterling Concertone chassis employs three screen-grid tubes and a two-stage a.f. amplifier with 245-type power tubes in push pull in the output. The electrodynamic loud speaker is supplied directly from the power unit. The Troubadour model lists at \$129.50, the Serenader at \$149.50, and the Imperial at \$187.50. All three sets use the Concertone chassis.

Padded Set Jackets

CHARLES J. WEBB AND COMPANY: This company makes padded jackets for use by dealers to protect radio receivers during shipment. They are made in three standard sizes.

Erla DeLuxe Console

ELECTRICAL RESEARCH LABORATORIES INC.: The Model 30 Erla receiver uses a seven-tube chassis with two screen-grid tubes, two 227's, two type 245's, and one 280. A long and short antenna control is provided on the panel. Tip jacks are provided for phonograph pick-up connection. The Model 30 lists at \$165.00.



Hammarlund Hi-Q 30

HAMMARLUND-ROBERTS, INC.: This receiver is unit built at the factory and comes to the purchaser in the form of several units which can be wired together quickly. The set uses nine tubes with an automatic voltage regulator, a three-stage tuned band-pass filter with screen-grid tubes, a type 245 push-pull amplifier, complete shielding, and a cadmium-plated chassis. To house the receiver nine special cabinets are available including one table model, six consoles, and two phonograph-radio combinations. Complete parts for the Hi-Q 30 a.c.-operated receiver list at \$162.50, parts of the tuner only (no a.f. amplifier) at \$138.65. The complete parts for the Hi-Q-30 battery-operated receiver list at \$119.15 and the tuner only at \$93.80.

Falck Screen-Grid Set

ADVANCE ELECTRIC COMPANY: The Model 11 is a small console receiver using a "Neutrocoil" loud speaker. A neutrodyne circuit with controlled regeneration is employed. List price: \$86.00. The Model 53 is a console set with an electrodynamic loud speaker. It uses screen-grid tubes and a 171A power tube. List price: \$112.00. The Model 23 lists at \$118.00 and uses a screen-grid tube and 245-type power tube.

Centro-Matic Tone Finder

EARL RADIO CORPORATION: The Earl Centro-Matic Tone Finder is an automatic tuning device which permits easy tuning to any one of ten favorite stations by simply pulling a lever. The Earl Model 33 containing this feature uses an eight-tube chassis with a phonograph pick-up jack. It lists at \$179.00.





THE SERVICEMAN'S CORNER

Screen-Grid Servicing

SCREEN-GRID problems are beginning to crop up regularly in the Corner's mail. DONALD F. SAMPSON, of Sampson's Radio Laboratory of Central City, Nebraska, writes on the subject as follows:

"One rather interesting experience I had with a defective screen-grid tube was when I found a set (Silver) that went off and on intermittently, and which could be either started or stopped by jarring the receiver. This generally indicates a loose connection somewhere in the circuit. The trouble, however, was found to be a short between the elements of the second r.f. tube.

"Although the Silver receiver is designed so that matching of screen-grid tubes is not necessary to prevent oscillation or to obtain the proper degree of selectivity, I have found that all screen-grid tubes are not good detectors. This is especially true where the tube is used as a power detector. A few cases have also been found where the detector introduced a considerable amount of a.c. hum.

The most common symptom of an inferior detector tube is lack of "kick," and this can almost always be remedied by interchanging the detector tube with one of the other tubes in the set. A poor detector tube may also cause a certain fuzziness in the tone quality of the machine. Of course, at times a noisy screen-grid tube will be found, but so far as the writer has been able to determine, the symptoms and the method of finding the defective tube are the same as for the 227 tube.

"My experience has been, using R.C.A. and Cunningham tubes, that screen-grid tubes are not 'short lived,' but, on the contrary, they will stand just as much abuse as any other heater-type tube. I have carried a Silver receiver on the floor in the rear of my car for over seven thousand miles, and not a screen-grid tube has been changed.

"I found one set in which all the voltages were about forty per cent. below normal, excepting the grid voltage of the 227 tube in the first a.f. stage, which was fifteen volts, instead of one volt. The trouble was found to be in the 227 tube and on replacement all voltages were correct, and the receiver operated properly.

"I have found more trouble with 227 tubes, because of a gaseous condition, than with 224 tubes, and believe that screen-grid tube troubles will be no greater than those encountered with the 227 tubes."

A complete test bench: The interesting test bench and panel illustrated on this

page is part of the equipment used by L. C. Wingard, service manager of the Cleveland Talking Machine Company, jobbers of Cleveland. With it, it is possible to test every piece of apparatus which is handled by the company. A General Radio

these are but part of the apparatus built into, on, behind, and under the bench shown in the picture.

A soldering kink: DOUGLAS B. SEVIN borrows a thought from welding technique in devising an arrangement for soldering in fairly inaccessible places. He uses a carbon rod, taken from a flashlight cell, affixed to any suitable holder. One side of a low-potential source—such as an A battery or a 2.5-volt filament winding—is connected to the carbon and the other to the connection to be soldered. The carbon is pressed lightly an eighth of an inch or so away from the point of soldering, and the joint is almost immediately heated to a solder-melting temperature.

The Crosley Bandbox:

"From observation, I have noticed that the Crosley Model 602 Bandbox condenser gang, gets out of line after a few months' of use. It seems that tightening the condenser drive bands too tightly has a tendency to warp the two end condensers gradually. If you examine the defective condenser closely in a case of this kind you will see that the rotor plates are not properly centered all the way across the condenser when it is at maximum capacity. This causes it to be

'in line' at one place and not at another. You will also note that the condenser has two adjustment screws on each side. Line these condensers up properly and balance the set with an oscillator and 'dummy' tube and you will find that the set has the original selectivity and volume."

H. ODELL PUHLES, Service Department, Vaughn's, Inc., Greensboro, N. C.

Data on Zenith sets: WALTER STRAUSS, JR. (w9CMX) runs into screen-grid and other troubles with Zenith sets:

"The early model Zenith screen-grid receiver employed a 224 for the first r.f. stage and either a 250 or 210 in the last a.f. stage. Two small 25,000-ohm resistors in series were used to reduce the 450 volts going to the plate of the last a.f. tube. The reduced voltage, about 135 volts, went to the screen grid. After several weeks of operating one of these resistors is apt to 'go west' and a good indication is: weak oscillations over the entire band; low volume; and broad tuning.

"To remedy this, use a 50,000-ohm resistor with the good 25,000-ohm unit and take out the bad one. The insertion of the 50,000-ohm resistor will cut down the screen-grid voltage to some extent but the volume will come to about par and so will the selectivity. I haven't had any trouble since the insertion of the 50,000-ohm resistor which was about 5 months ago.

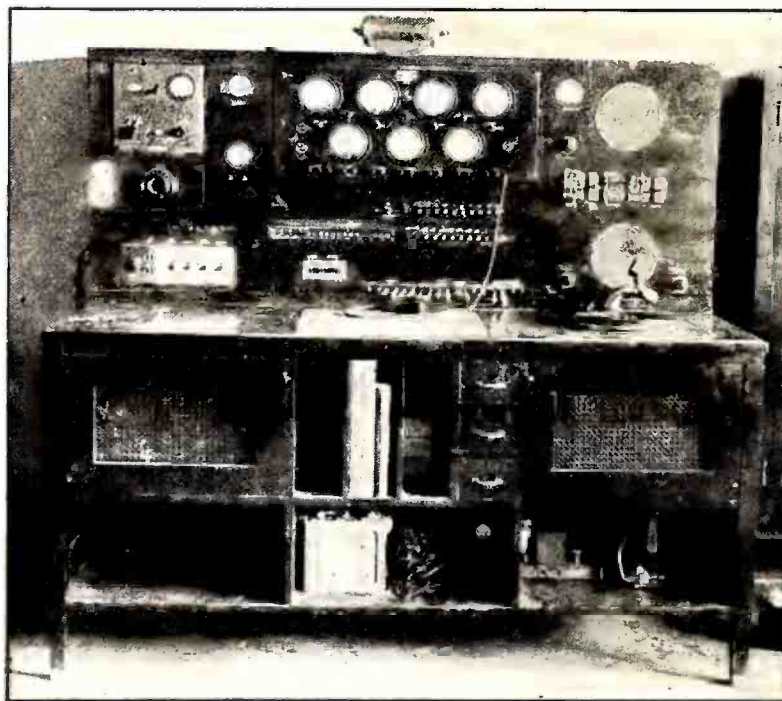

The test equipment pictured above is the apparatus employed by the Cleveland Talking Machine Company. It is designed so that all types of tests may be performed on the apparatus which they sell as wholesalers.

oscillator designed to test Radiola 64's but remodeled so that it will cover the broadcast band; two loud speakers, a magnetic and a Radiola 104, switches for using either low- or high-impedance pick-up units; complete power apparatus furnishing various voltages and currents—all

The serviceman is consistently confronted with the mechanical problems of installation and maintenance. A specific case is the installation of a moving-coil loud speaker so that it offends neither the eye nor the ear. It is unfortunately almost a corollary that for an electrodynamic loud speaker to be efficient acoustically it must present to the eye a cross between the smokestack on Peter Cooper's locomotive and an ironing board.

We should appreciate contributions from servicemen describing the reconciliation of electrical and mechanical efficiency with the dictates of good taste in the well-appointed home—from antenna lead-ins to loud speaker camouflage.

—THE EDITOR.

"In these same models, when a pilot lamp becomes loosened or burnt out it is a very hard thing to put your fingers inside the frame of the dial and replace the lamp. After cutting up my fingers it finally dawned upon me to use a rubber tube with an inside diameter equal to the lamp or a little smaller, and about three or four inches long. After the threads are given a start it is then easy to tighten the lamp all the way.)

"A good rough indication of the 224 and its respective circuit may be obtained by placing your finger on the cap terminal of the tube. If the music stops it is good. If not, it is most likely to be a low tube and should be replaced as soon as possible as it lowers the efficiency of the other tubes."

Servicing Radiolas

M. R. BATTERSBY, in charge of the radio repair department of the Manhattan Electrical Supply Company, New York City, sends along the following data on a portable oscillator for servicing superheterodynes:

"Some time ago I was called upon to design a really portable 175-180-kc. oscillator to be used in servicing superheterodynes. So with two items in mind, namely portability and minimum cost of construction. I built the following oscillator in which a UX-112A tube was used with batteries consisting of a 4.5-volt C battery as the A supply (which is good for about 15-20 hours continuous running of the oscillator filament) and B supply consisting of a small 22.5-volt B battery. If greater output is desired two of these B batteries can be used in series, although two are not necessary for satisfactory operation.

"An aluminum shield can measuring 4.5" high by 5" square was cut to measure 2.5" high by 5" square. This was easily accomplished as the can was of the collapsible type held together by eight screws, allowing the removal of any part. The flat sides and supports were cut with a hack-saw to size and smoothed with a file after which the side supports were drilled and tapped for $\frac{5}{32}$ screws so that the top could be fastened on again in the original manner. The 5" by 5" top holds all the apparatus indicated in the diagram and the pictures.

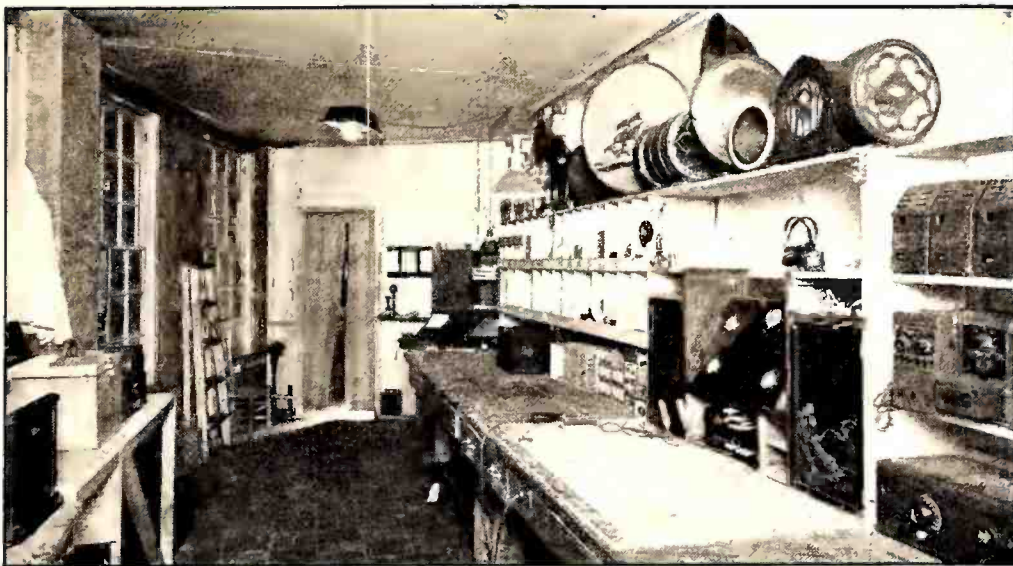

The well-planned service shop of Vaughn's, Inc., Greensboro, N. C., specialists in Sonora, Majestic, and Crosley receivers.

"A feature of the oscillator and one which makes possible its compactness, is the oscillator coil itself which is the secondary coil of an i.f. transformer

any small wire are put on for the pick-up coil. The secondary coil is tuned to 180 kc. with the original condenser supplied in the i.f. transformer for that purpose or by means of a balancing condenser (R.C.A. part No. 2239).

"For 175 kc. a balancing condenser (R.C.A. part No. 2239) is paralleled with the 180 kc. condenser by means of a Yaxley single-pole jack switch. The diagram is shown on this page.

"After construction, the oscillator is calibrated by means of a Radiola 60 receiver for 180 kc. and a Radiola 66 receiver for 175 kc. The method is as follows:

"For 180 kc. the pin jack leads of the 0-5 or 0-10 milliammeter are placed in series with the plate lead of the second detector in the receiver, a Radiola 60. This can be done either by an adapter or by breaking in on the red plate lead at the terminal board. Place all the tubes in the receiver with the exception of the oscillator. Clip a pick-up wire to the middle stator section of the variable condenser bank in the receiver and attach the other end of the wire to the pick-up jack on the oscilla-

tor. With the receiver and oscillator both operating adjust the tuning condenser No. 1 across the coil in the oscillator for maximum reading on the milliammeter which will indicate resonance at 180 kc. If the loud speaker is connected to the output terminals of the receiver the note of the oscillator will be heard with good volume, its pitch depending on the value of grid leak used.

"To calibrate the oscillator for 175 kc. throw the jack switch on the oscillator panel to parallel the secondary condenser No. 1 just tuned, with the condenser No. 2, as yet unused, taking care not to disturb the adjustment of the first condenser. A Radiola 66 receiver is used for this calibration and the procedure is the same as when calibrating with the Radiola 60. The pick-up lead is clipped on the middle stator section of the variable condenser bank in the receiver and condenser No. 2 in the oscillator is adjusted for maximum reading of the milliammeter. After calibrating it is wise to seal the small condensers in the oscillator with a bit of wax to insure the adjustment remaining permanent."

[By substituting a coil of about 100 turns, wound on a three-inch form and centertapped, for the R.C.A. No. 8342, this oscillator may be used for service work on the broadcast band.—Editor.]

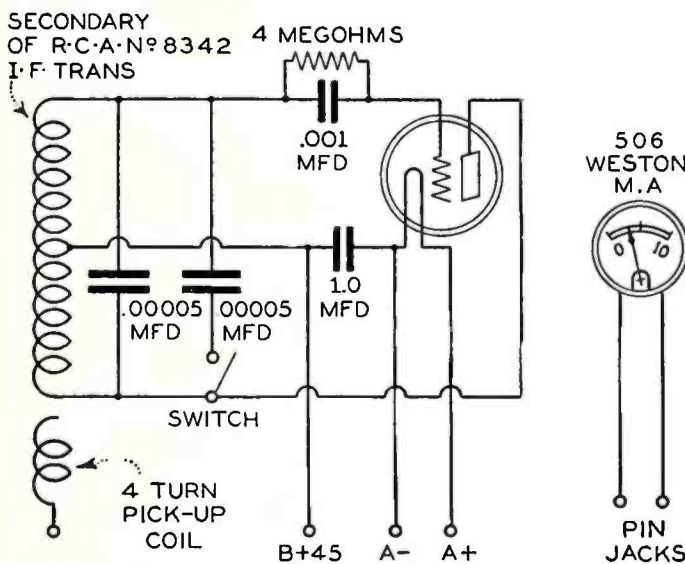

The complete schematic diagram of a fifteen-dollar home-made portable oscillator.

for the Radiola 60 (R.C.A. part No. 8342). The case of the i.f. transformer is taken off, the coil is demounted, and the primary winding is removed. Then four turns of

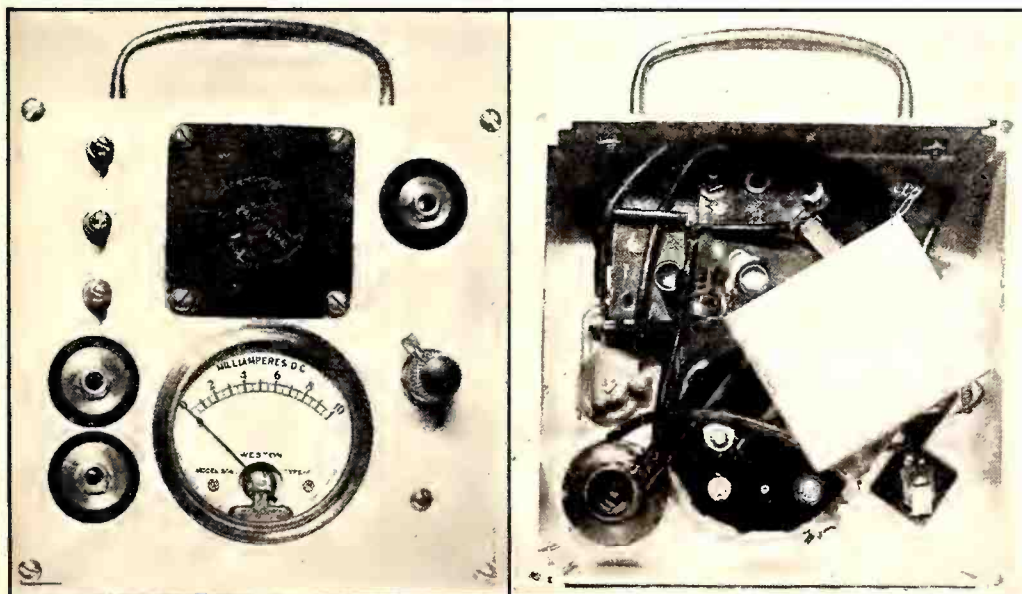

Two views of the portable oscillator described by Mr. Battersby. This instrument was designed especially for servicing superheterodyne receivers.

ELECTROSTATIC LOUD SPEAKERS

By F. J. SOMMERS and G. E. MATTOS

Undergraduates, University of Santa Clara

THE PURPOSE of this article is to describe some interesting features in connection with a recent type of electrostatic loud speaker and to discuss its electrical and acoustical characteristics as determined by engineering tests.

At the present time, as is generally conceded, the electrodynamic loud speaker, which makes use of a moving coil in a strong magnetic field, is the most powerful and efficient sound reproducer that engineering science has developed. It is not only a satisfactory loud speaker from the engineering standpoint, but its even response, good tone quality, and ability to transform comparatively large audio-frequency currents into sound, have made it exceedingly popular with the radio public.

Despite this tendency toward loud speakers of the electrodynamic type, interest has lately been aroused in certain electrostatic loud speakers now in the course of development, which, because of their simplicity, may be manufactured at a comparatively low cost.

Engineers in general are, for good reasons, inclined to look with disfavor upon any device which transforms electrical energy into mechanical through the medium of electrostatic attraction and repulsion alone. Everyone knows that the sources of power loss in such devices are many, that electric charges are prone to leak off before they can be put to use, and that even where the best dielectrics and best design are used, the loss of energy due to dielectric hysteresis and corona effects is liable to be considerable. If high voltages are used, these losses are greatly magnified, though they are also present when comparatively low voltages are employed.

While many claims are being made in favor of electrostatic loud speakers, at the present time there is little engineering data available as to their characteristics, and it was for this reason, coupled with the widespread interest in such devices, that the tests described in this article were undertaken.

Mechanical Construction

The mechanical construction of the loud speaker tested is as follows: The back plate (see Fig. 1A) is a disc of 24 gauge sheet-iron thirty inches in diameter,

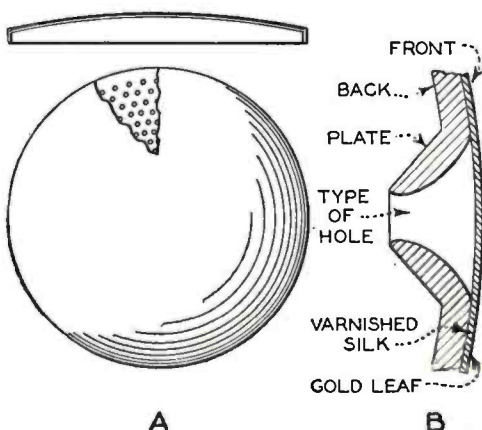

Fig. 1

whose periphery is bent up to form a flange half an inch wide. In this back plate are punched some 2000 quarter-inch holes, the holes being punched so that there is a sharp bur at the back of the plate, but none in front. In addition to this, the back of the plate is "dished-in" half an inch, as shown in the figure. Over this back plate is stretched a membrane of varnished silk two-thousandths of an inch thick, and a layer of imitation gold foil is applied to the outer surface of the membrane. An enlarged cross-section of the loud speaker is shown in Fig. 1B, which shows the type of hole punched in the back plate, as well as the relation of the varnished silk and the gold foil with respect to the back plate.

In using this loud speaker, it may be

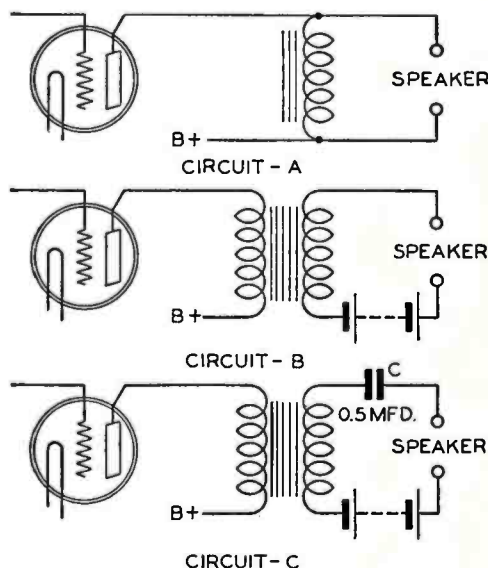

Fig. 2

connected to the amplifier in a number of ways—three of which are shown in Fig. 2. Referring to Fig. 2, circuit A is one in which no external source of bias voltage is used. In circuit B, bias potential is supplied by means of a battery. Circuit C is the same as circuit B, except that the resonant frequency of the loud speaker and effective inductive reactance of the output transformer have been altered by placing a condenser in series with the loud speaker. These circuits were chosen for tests because the results obtained could be analyzed more easily with respect to the effect of the resonant frequencies of the loud speaker circuit and the effect of various bias voltages.

For the sake of clarity in explaining its characteristics, the theory of the loud speaker in question will first be outlined. It can be seen that the electrostatic loud speaker is nothing more than an electrostatic condenser, one of whose plates is fixed, and the other is free to vibrate. When the condenser charges, there is an attractive force which pulls the diaphragm more closely to the back plate. When it is discharged, there is a certain restoring force supplied by the elasticity of the diaphragm which pulls it back to its initial position. It can be seen, therefore, that the dia-

phragm will vibrate in accordance with voltages across the loud speaker.

Source of Sound

It might be thought that the foregoing was the entire theory of the loud speaker, and that the holes in the back plate were merely for the purpose of allowing air to escape. On the contrary, we have found that very little of the sound comes from vibration of the diaphragm as a whole, but that most of it comes from a more intense vibration taking place in the parts of the diaphragm immediately over the holes. It is proposed by the authors that this increased vibration is partly due to distortion of the electrostatic field about the holes, in such a way that there exists a large difference of potential between the sharp burred edges of the holes, and the parts of the diaphragm over the holes. The electrostatic field about the holes is by no means uniform, and changing the shape of the holes may greatly alter the distribution of electrostatic flux lines between the membrane and the back plate. This increased vibration is also partly due to the curvature of the holes from the front inward. As shown in Fig. 4, the vibration of the membrane may be thought of as a progressive process. As the diaphragm rolls inward over the hole in Fig. 4, it can be seen that there is always a comparatively large force on such parts as A for position I and B for position 2.

In addition to this, the authors have found that when large holes are used, the loud speaker responds more easily to the lower frequencies, while if smaller holes are used, it responds better to the higher frequencies.

From theoretical considerations, the response of the loud speaker with change of frequency may be said to depend mainly upon the following factors: mechanical resonance points in the back plate caused by the particular construction used; the size of hole used; the shape of hole used; the electrical resonance effects due to the circuit used in connecting the loud speaker to the amplifier; and the magnitude of the bias potential applied to the loud speaker plates.

It can be proven both mathematically and by experiment that harmonic dis-

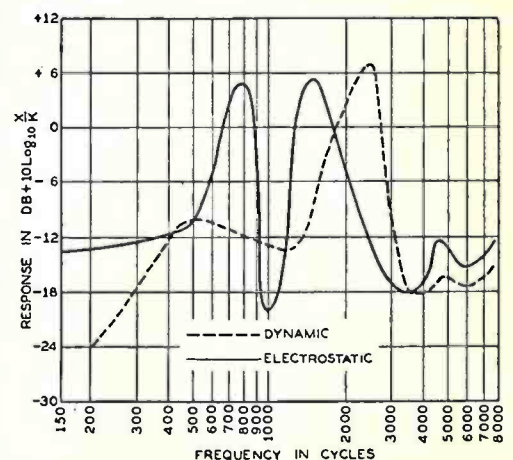

Fig. 3

tortion in the loud speaker can be reduced greatly by application of bias voltages which are large in comparison with the varying audio-frequency voltages supplied by the amplifier.

Electrical Efficiency

The method of test and the results obtained will now be discussed.

For the particular case of a loud speaker, efficiency, as it is generally defined, is not of the greatest interest. Since it is the duty of a loud speaker to utilize all the available power that can be supplied to it by the input circuit, a ratio of output watts to watts input cannot adequately describe its worth. Therefore, in testing loud speakers, efficiency is defined as the ratio of the sound output in watts to the maximum power in watts the supply circuit is capable of delivering under the conditions of optimum impedance. This efficiency ratio in turn is usually expressed in Decibels, or ten times the logarithm to the base ten of the ratio of the output watts to the total available input watts.

In order to test the efficiency of the loud speaker, the authors devised the circuit shown in Fig. 6. The procedure in making measurements was as follows:

The oscillator was first set at a given frequency, as for example, 500 cycles. Switch A was thrown to position (1) and Switch B also to position (1). The alternating component of the voltage drop E_1 , across the non-inductive resistor was read with the vacuum-tube voltmeter. The total power available from the amplifier was then expressed by the equation,

$$P_1 = E_1^2 \times K$$

where K is a constant. Switches A and B were then thrown to position (2) and the sound-power output of the loud speaker was then expressed as:

$$P_2 = E_2^2 \times X$$

where X is a variable function, depending upon the frequency only if the volume of the sound issuing from the loud speaker is kept fairly constant by using larger or smaller inputs. The response of the loud speaker in dB was then expressed by the equation:

$$R = 10 \text{ Log}_{10} \frac{P_2}{P_1} = 10 \text{ Log}_{10} \frac{E_2^2}{E_1^2} \times \frac{X}{K} = 20 \text{ Log}_{10} \frac{E_2}{E_1} + 10 \text{ Log}_{10} \frac{X}{K}$$

Since the value of the term $10 \text{ Log}_{10} X/K$ depends upon the frequency only (assuming a reasonably constant sound output), it will be seen that the response curve of the loud speaker will be raised or lowered at any ordinate by the value of $10 \text{ Log}_{10} X/K$. Readings were thus taken over the frequency range of from 200 to 6000 cycles, and a curve of response versus frequency as abscissas was plotted.

Response Characteristics

Since the actual power represented by the sound coming from the loud speaker is only a few microwatts, it is exceedingly difficult to calibrate the apparatus so that absolute values can be obtained. In order, therefore, to get the response of the electrostatic loud speaker without actually calibrating the apparatus,

a high-quality modern electrodynamic loud speaker was placed in the same position as the electrostatic and the readings repeated over the frequency range of 200 to 6000 cycles—enough readings being taken to make an accurate curve. By plotting the

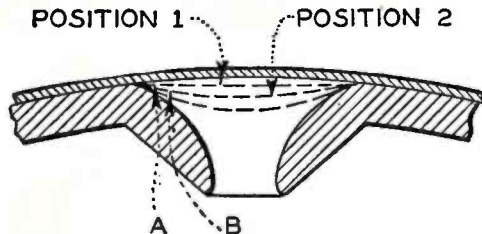

Fig. 4

curves of both electrodynamic and the electrostatic loud speakers on the same sheet, the difference in their responses in dB at any ordinate may be read off the curve, since both curves are raised or lowered at any ordinate by the same amount, namely $10 \text{ Log}_{10} X/K$. Difficulties will be encountered, however, if attempts are made to find the difference in response

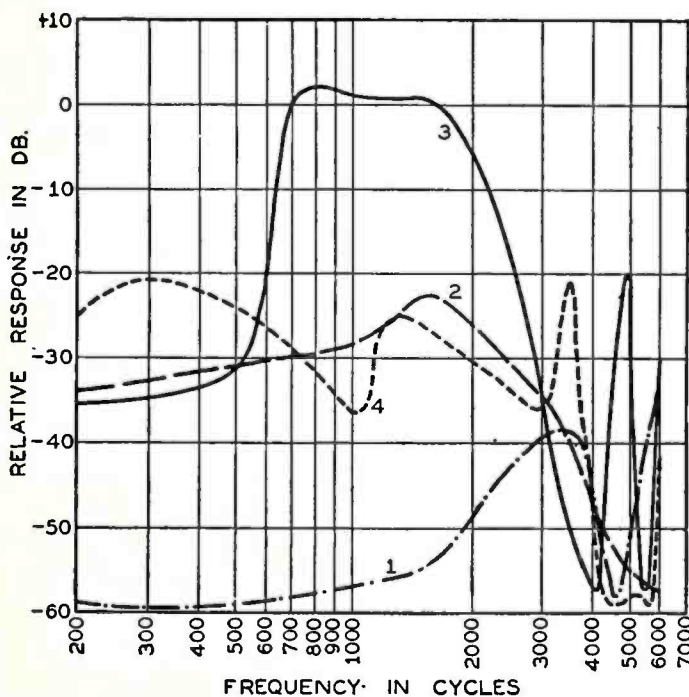

Fig. 5

at ordinates where the responses are of different sign. Fig. 3 shows two such curves plotted on the same sheet. It can be seen that the response of the electrostatic loud speaker is better than that of the electrodynamic by -10 dB. at 200 cycles. At 420 cycles they are equal. At 500 cycles they are again equal. At 1000 cycles the electrostatic response is less than the electrodynamic by -6 dB, at 1800 cycles and 3500 cycles the responses are equal, and so on. This set of curves indicates that the response of the electrostatic speaker was uneven as compared to that of the moving-coil type.

In Fig 5 we have a set of curves of the response of the electrostatic loud speaker

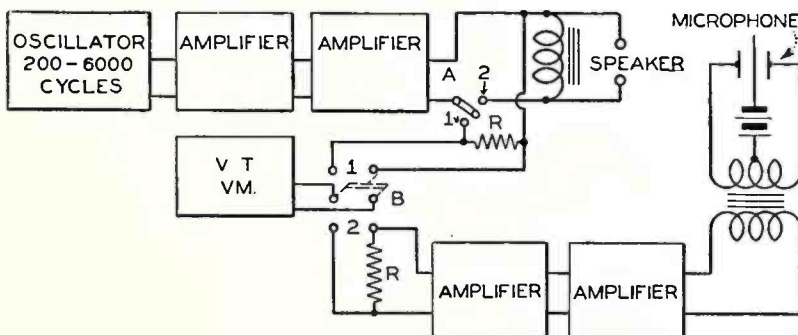

Fig. 6

plotted upon the assumption that the curve of the electrodynamic is a straight line. Curve 1 is for the loud speaker using circuit B (Fig. 2) and a bias potential of 25 volts. Curve 2 is for circuit B and a bias potential of 100 volts, and curve 3 is for the same circuit with a bias of 250 volts. Curve 4 shows the relative response of the electrostatic loud speaker when a 250-volt-bias and circuit C are used.

Without going into a detailed discussion of these curves, it can be seen that, in general, the larger the bias potential used, the greater will be the response of the electrostatic loud speaker. It is also seen from curve 4 that changing the resonant frequency of the loud speaker circuit by inserting different values of capacity (0.5 mfd in this case) in series with the loud speaker, changes the shape of the response curve.

In general, it is desirable to have the main resonant frequency of the loud speaker circuit considerably above the highest frequency at which it will be used.

Volume vs. Bias

While a bias voltage of 500 to 600 volts or more is desirable for good results, fair reproduction is obtained with this loud speaker when only 200 or 300 volts is used as a bias.

As shown in Fig. 5, the volume of sound delivered by the loud speaker for a given input voltage increases as the bias voltage is increased. It is also true that harmonic distortion decreases as the ratio between the bias voltage and the amplifier voltages applied is increased. Although in a.c. machinery, only odd harmonics occur, in the case of the electrostatic loud speaker both odd and even harmonics may be present. In other words, if an initial frequency of 500 cycles is applied to the loud speaker, we may have 1000 cycles, 1500 cycles, or any other frequency or combination of frequencies which are integral multiples of 500 cycles. This combination of the original frequency with its harmonics, gives rise to a sound wave which is distorted with respect to the original frequency, and the effect is called harmonic distortion.

When attempts are made to reproduce music by means of a loud speaker in which harmonic distortion is present, the quality is poor. This is the case when the electrostatic loud speaker is operated at low bias potentials. If, however, the bias is increased, this distortion will be reduced. Let the bias potential across the loud speaker be denoted as E and the varying voltage supplied by the amplifier expressed as $e \text{ Cos} \omega t$, then the force upon the diaphragm tending to make it vibrate may be expressed approximately by the equation.

$$F = 2KEe \text{ Cos} \omega t + \frac{1}{2} Ke^2 + \frac{1}{2} Ke^2 \text{ Cos } 2\omega t$$

It can be seen from this equation, that by increasing E, the harmonic term $\frac{1}{2} Ke^2 \text{ cos } 2\omega t$ becomes less important, and if the bias potential is increased to a high enough value, it will be negligible.

The humps in the curves in Fig. 3 are not entirely dependent upon the electrical characteristics of the loud speaker circuit, but can be seen to depend also upon the various mechanical resonances which may be present in the back plate and the diaphragm of

(Concluded on page 122)

SETTING RADIO STANDARDS

By **KENNETH W. JARVIS**
Chief Engineer, Sterling Manufacturing Company

A NEW RADIO set is being made. It may be a marvelous achievement or just another radio set. It may be in great demand or unheard of. Just what technical details will make this new set what it will be? Why will it work the way it does and not like some other make of radio receiving set?

The determination of how good a radio receiver should be, and the maintenance of that degree of "goodness" is one of the most fascinating problems connected with the radio industry. It is a curious balance between human discernment and the laws of probability. It involves a conflict between individual temperaments and engineering preciseness. And perhaps most of all, it is a problem in economics from the viewpoint of the manufacturer.

The setting of a standard of performance is a fundamental problem to which a correct answer must be obtained by any manufacturer hoping to stay in the radio business. It is surprising to note the indefiniteness with which this problem is viewed by a great many manufacturers, and it is significant that the most successful producers are those who have approached the problem in a logical manner. The following discussion presents one possible approach, and considers some of the factors involved. Not a great many figures are included, and then only for illustration, as quantitative values are of interest only in specific cases. The relative standards of performance are so varied by market and manufacturing conditions as to make the correct choice a matter of company policy rather than the sole answer to what is the best type radio set to make.

Relative Standards

By relative standard is meant a hypothetical receiver, comparable to previous or competitive models, whose performance capabilities are guessed at as a function of development possibility, cost, and customer demand. It may be an expensively engineered, high priced, refined, beautifully operating receiver, appealing to the tastes of those who can afford such details. It may cost but little, serving to give those less favored in worldly goods some of the joys and static of radio reception. In either case, the operational characteristics have a relative standard about which level the policy of the manufacturing company tends to keep the manufactured article. The company policy, and as a consequence, the relative standard, is influenced by the time and cost of development, the cost of production and materials, and the sales demands. A brand new company would hardly be justified in building the finest and most expensive radio set its first year; the time needed for development alone would prevent such a move. Nor does this mean that the older companies will all tend to go toward higher price and finer

operating receivers. The trend might more nearly be toward that price and performance compromise which would give the manufacturer the greatest profit. As production increased year after year and more money could be spent in develop-

A lower price demand may result in a lowered standard, and conversely. These facts merely mean that to occupy a place in the radio field a manufacturer must choose his relative standard as based on these facts; and for each manufacturer and his particular conditions, a receiver design with a definite relative standard is advisable.

Absolute Standards

By absolute standard is meant a standard working model, which is copied for production as nearly exact as economically possible. It represents, crystallized into facts, the fancies of the relative standard. This standard is established and built in three steps. First, the details required are added to the relative standard by the management of the design division. Usually this means the individual highest in the organization interested in the radio receiver. In the case of a radio receiver manufacturing company this is customarily the president. For more diverse concerns, it may be the vice president or manager of the radio division. These details may cover the suggested size, appearance, manner of construction, sensitivity, selectivity, fidelity, output, number and manner of controls, type of circuit, maximum possible cost, date for production, number to be built, and those extras which may serve to make the product more marketable. Meetings between the executive, engineering, production, and sales departments serve to resolve difficulties and effect compromises. As a result an absolute standard (still on paper) is evolved which the engineering department believes can be constructed in the time available and at the cost specified, and which the production department can build. This is the first step.

As a second step, the engineering department takes these ideas and builds a model which conforms as close as possible to the proposed absolute standard. This model must represent previous development work and the experience of the engineers in charge. Newly proposed additions must be developed so far as possible in the time available. General development work, applying previously determined factors, must be carried on with this specific receiver in view. When engineering principles are applied to produce a desired performance in a physical model, cost studies must be made to show whether the method of application is the cheapest and whether the result justifies the cost. As a result of this work and study, a receiver is evolved approximating the characteristics desired for the absolute standard. Unfortunately, due to human limitations, it is seldom possible for the engineering department to realize all of the ideals of the first chosen absolute standard. A compromise is effected, sometimes bitterly, for competition is keen, but a second stage

Production engineers are faced with a two-fold problem; to build a certain number of units per day, and to determine which of those units will be shipped and which will be scrapped. Mr. Jarvis in this article discusses the problem of the engineers who must set performance limits on radio receivers and component parts; he discusses from a practical standpoint what the passing and rejection limits should be, the relation between performance and cost, and other factors which are no less vital to a successful radio manufacturer than the careful laboratory design of the apparatus.

—THE EDITOR

ment, the relative standards of that manufacturer might increase. Long experience in manufacturing, refinement in methods of production, and fabrication of materials tend to raise the relative standards. Changing customer demands react in changing the performance standards.

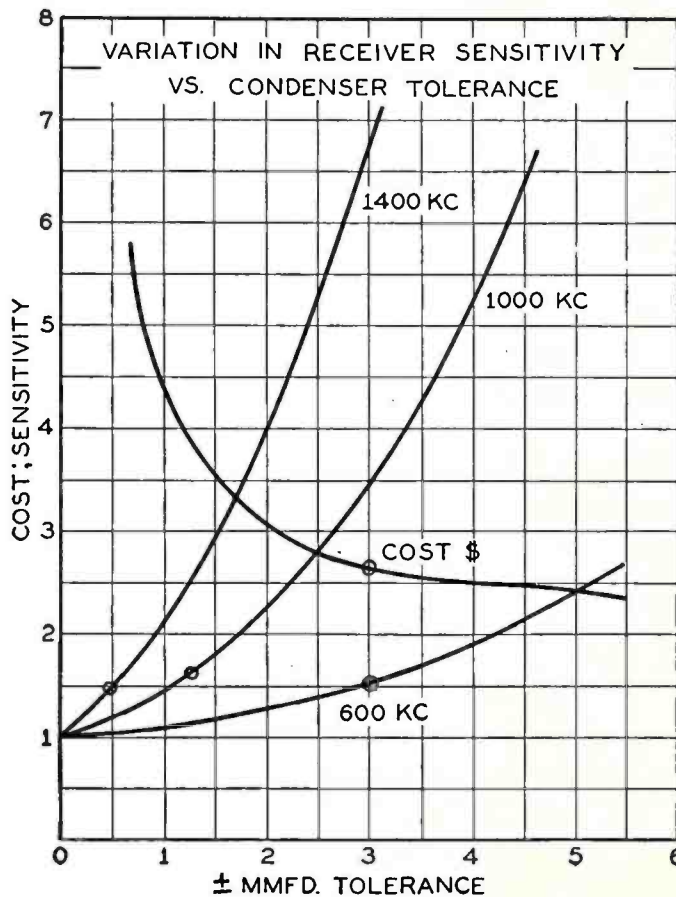

[Fig. 1

in the making of an absolute standard has been passed.

Production Starts

The engineering department model is then copied, drawings are made, dies constructed, and parts purchased. The planning and production departments disassemble and reassemble, figuring labor costs and the most economical way of doing things. Minor changes are made to gain savings of time and material, and to conform with better production methods. Preliminary production work builds a dozen or more samples, each of which is examined and measured, noting how it fits into the scheme of things. If these samples prove satisfactory, the real production is started. Cautiously, for even the engineers sometimes slip, the production increases, the variations and the effect of production expediencies being carefully noted. The production average is checked against the sample average and against the engineering department standard. Differences are corrected or compromised, and the production grows. As a result of this mass copying, the absolute standard loses its individuality; it becomes an average value. There is no longer any single model which is the standard. The absolute standard has been reduced from an intangible idea to a physical reality, and back to a synthesis of microvolts per meter, band width in kilocycles, and percentage responses at 60 cycles. The setting of the absolute standard is complete.

A second problem which should be coincident with the setting of the absolute standard but is usually subsequent thereto, is the setting of the passing and rejection limits of the individual units. There are both absolute and quantitative rejections, mechanically and electrically. In the case of mechanical details, an absolute rejection might be due to a broken dial, or a defective socket. Mechanical quantitative rejections might be due to play in drive mechanism, scratches, etc. Electrically the absolute rejections might be due to no signal or oscillation. Quantitative rejections electrically might be due to low sensitivity, poor selectivity, bad quality, too much a.c. hum, and low overload capacity. The mechanical defects, both absolute and quantitative, are usually caught by competent inspectors who use their own discretion. Electrical defects are caught by meters which are calibrated to indicate the values of the relative performance characteristics. A failure of the meter to read a predetermined value on any test means a rejection. All of which sounds simple, and it is simple, if these values are correctly predetermined. It is in the determination of these limits that the engineer is prone to err.

Rejection Limits

Inspection to determine the electrical performance of radio receivers may be viewed from two standpoints. The inspection and the limits may be set to maintain a high quality of product, or to detect and reject a subnormal set. The first viewpoint is the customary one; the second is the correct view from the economic standpoint. Nor are these two views synonymous as a first impression might indicate. To insure a high quality of product, all units should closely approach

the absolute standard in all electrical characteristics. If the rejection limits correspond to the value placed on the absolute standard it is obvious that all sets shipped will be equal to or better than the absolute standard. It is equally obvious that only 50 per cent. of the receivers built will be shipped, as the absolute standard has been chosen as the average of all the sets produced. Such a limit is ridiculous. If the limit is pushed further toward a lower standard, more sets will

watts to 15 watts be a cause for rejection if the receiver is to be used in a small home. If a manufacturer can show that 50 per cent. of his receivers are used for local purposes only it will undoubtedly, and justifiably, result in a broadening of his sensitivity limits.

Accessory Variations

Another method of determining the allowable variation in receiver characteristics is to consider the accessory variations. It seems illogical to insist on maintaining production limits much closer than the variation resulting from factors over which the manufacturer has no control. A reasonable figure at first guess is to hold the set variation within 50 per cent. of that due to the accessories. In the modern radio set six, seven, or eight tubes are used. While the deviation in these tubes (mutual conductance) approximates 15 per cent., the effect on the set characteristics may be more or less, depending on the product of the stages and the criticalness of design. Measurements of the receiver characteristics with high and low tubes will show the magnitude of the variation. Line voltage variation, if not compensated, also causes a performance variation. Some receivers are quite critical to voltages, others seem to vary in direct proportion, while in one instance, over the normal voltage range of 105 to 125 volts, the sensitivity was almost independent of the voltage. Loud speaker variations may also allow the receiver proper to have greater permissible variations. The place where the receiver is operated, as in a large room, or in a location with poor acoustic condi-

tions, influences the sensitivity and quality demands. One of the greatest variations lies in the "pick-up" ability of the antenna used. When the apparent sensitivity of a receiver can be quadrupled by merely increasing the size of the antenna, why manufacture and hold it within 10 per cent. of the absolute standard? Combining all of these accessory variations gives a figure which is surprising as a possible variation for an individual unit.

While hardly a direct method for determining the rejection limits, a major influence is the repair cost. If the repair cost is high, as is generally the case, it is economical to put more money into making a uniform product and thus cut the percentage of rejections. This, based on nonuniformity of the product, means relatively wider limits. Conversely a low repair cost or a high scrap value tends to narrow the rejection limits. When the cost of rejection and repair becomes appreciable with respect to the original cost estimate, poor engineering, poor production methods, or poor setting of the rejection limits are indicated.

As before indicated, a general method of setting the rejection limits is to adjust them so as to reject arbitrarily X per cent. of the sets built. This is fundamentally not a standard at all as it is too easily changed to meet production demands. The X per cent. rejected tends to raise the standard while the 100-X per cent. meets the production demands. While this method is hardly good business, it is unfortunately quite common.

Another Method

Any of these methods might be used if the object of the inspection tests is to

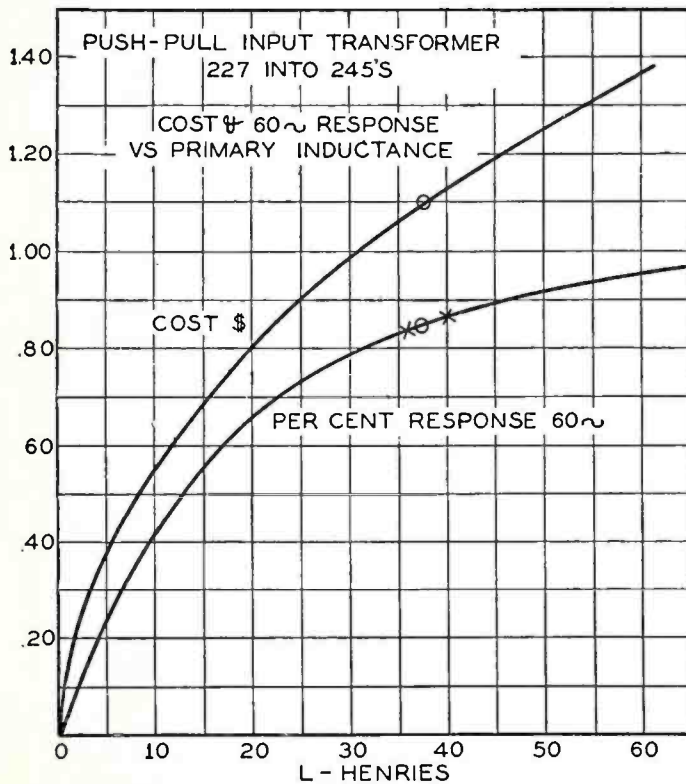

Fig. 2

be passed and fewer rejected. How far should this "pushing" be carried on? What is a safe basis for setting a rejection limit?

There are several methods which might be used to determine what variation in product should be allowable and so determine the limits of rejection. Take as a first method that of customer discrimination. By many experiments it is shown that the average ear cannot detect a difference in sound intensity of less than 15 per cent. (Fletcher: *Bell System Technical Journal*, Vol. IV, No. 3, p. 376). It might be foolish to maintain limits so close that a single individual could not hear the difference. The average customer expects a slight difference between units. He knows that all receivers cannot be identical. Should

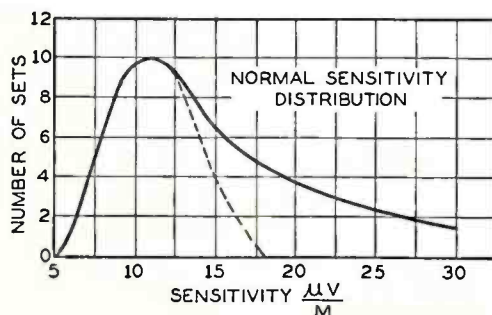

Fig. 3

not the manufacturer capitalize this expected difference in units by broadening his limits? Then again, many receivers are used in certain ways where limits do not greatly matter. Certainly a 10 per cent. reduction in sensitivity will not affect the intrinsic value of a receiver used for local reception only. Nor will a reduction of possible power output from 20

mercy keep the quality standards high. However, a brief consideration of what a radio receiver consists of, and its primary object, shows that the above methods are quite wrong. The limits should not be set as a secondary standard from the absolute standard, but the absolute standard should be determined as the mean probable variation from the minimum permissible performance rating. The comparison is between determining the average of production and setting logical limits therefrom, or the initial choice of a passing point, with the receiver then designed so that all normal units will satisfactorily pass.

This seems a fine point, but it means the difference between a smooth running engineering, production, and inspection system, and one which must continually make engineering changes while in production, and endure the resultant changes in the absolute standards and rejection limits. If this ideal can be brought about, as is gradually being done, a receiver can be designed, produced and marketed with a minimum of friction and expense. It requires a careful consideration of design factors to produce the most economical receiver.

Assume it is desired to produce and market a receiver with a sensitivity of 20 microvolts per meter or better. If the absolute standard is fixed at 15 microvolts, a high degree of uniformity is necessary so that the variation should range only between 11 microvolts and 20 microvolts. A close inspection and close limits on the individual components in the receivers must be maintained. This means a high cost for the parts and an excessively high cost for the completed set. Or if the absolute standard be set at 10 microvolts, the fundamental design will be more expensive, perhaps due to the addition to another stage of amplification, better coils and better shielding, etc. However, the individual components will be less expensive due to the greater permitted tolerances, for the overall of the set may vary between 5 and 20 microvolts. (Note that the absolute standard is not the *average* of the two extremes of sensitivity of the normal receiver. The absolute standard is more nearly the geometric mean of the two extremes.) The total cost of the set may thus be less with an absolute standard of 10 microvolts than with a standard of 15 microvolts if 20 microvolts is determined upon by company policy as the rejection limit. It is obvious, therefore, that the methods of determining the absolute standard as outlined in the beginning cannot be followed so simply if the most economical design is to result. If both a maximum and minimum performance rating is desired, the choice of these limits is truly an economic problem. Too great a sensitivity and oscillation may result. Too poor a sensitivity and the set will not match its competitors. A demand of too great a uniformity (close plus and minus rejection limits) will increase the cost enormously.

Limits vs. Cost

This method of setting limits of performance as based on cost and company policy, rather than an absolute standard plus arbitrarily set limits, is ideal. It is not always possible to make the best choice due to time limitations. However, the practice of setting a desired absolute standard the *proper* amount better than the rejection limits, is a step in the right direction, and is a step which should be taken whenever a new receiver design is proposed. It is quite apparent that the effect on the overall performance of the receiver of each individual component

must be known in order to approximate this ideal method of setting receiver standards and rejection limits. On the same curve must be plotted the cost of the component *vs.* the characteristics of the component. Often the correct characteristic of the component desired at a given cost can be determined at a glance. At other times the proper design of the component can be determined only when other parts of the receiver are considered. The idea involved is simple and logical. Hold the limits on those critical components close to the desired value and do not spend good money to hold those non-critical factors close to a limit.

It is obvious to most engineers that to hold a fixed resistor to within plus or minus 1 per cent. of its rated value is uneconomical, while to hold a variable tuning condenser to approximately the same limits is quite advisable. Yet, even in the case cited, it is doubtful if many could show the actual variation in receiver performance with variation in resistance or tuning capacity. It is customary at present to purchase fixed resistors under a plus or minus 10 per cent. guarantee. Why? Is this limit too close or not close enough? The answer lies in its proposed use. There is a growing tendency to use resistors of plus or minus 5 per cent. for bias voltages, and as high as plus or minus 30 per cent. for use as grid leaks.

Actual Data

Two curves showing such actual design data are included to illustrate these points. The first shows the variation in receiver sensitivity as the tolerance in the tuning condenser is increased. This receiver used a four-gang condenser and for these data two condensers were placed at the maximum indicated plus tolerance and two at the negative tolerance. The average of all possible combinations of the four condensers with any chosen tolerance is taken at the observed point. As this receiver is a variable capacity tuned instrument, the capacity has a greater value as the frequency is decreased. A given deviation in capacity is a smaller percentage of the tuning condenser at 600 kc. than at 1400 kc. and results in a smaller change in sensitivity. Taking the relative sensitivity at 600 kc. when perfectly tuned as one microvolt per meter, and allowing a 2-micromicrofarad tolerance, then the sensitivity will be reduced about 25 per cent. to 1.25 microvolts. The same tolerance at 1000 kc. would reduce the sensitivity to 2.3 microvolts per meter and at 1400 kc. the sensitivity would go to about 4 microvolts per meter. The cost of the condenser gang is given as a function of tolerance allowable. The increased cost with increased accuracy is obvious. This curve refers to the relative cost of the condenser in the 600-kc. position only. The deviation between condensers usually decreases as the rotors are turned out of mesh with the stators. It is fortunate that this is true as it would be difficult to maintain a large capacity within the variations allowable at 1400 kc. With this data available, what capacity variation should be set as the limit permitted? In this case the limits were set as shown by the circles, the tolerances being plus or minus 3 micromicrofarads at 600 kc. with a resultant sensitivity variation (due to this factor alone) of minus 55 per cent. At 1000 kc. the corresponding values are 1.25 micromicrofarads and 65 per cent., and at 1400 kc. they are 0.5 micromicrofarads and 45 per cent. The cost with these limits is approximately \$2.70. Incidentally it is obvious how important it is to align properly the minimum capacity of all circuits at high frequencies to maintain the sensitivity.

Another Example

The second curve refers to the design of an audio amplifying transformer working from a 227-type tube to a pair of 245-type tubes in push pull. The turns ratio on each side is a 2 to 1 step up. The calculations for cost assume that both copper and iron increase as the inductance increases. This is necessary to keep the cost at any chosen inductance at a minimum. Too much iron, or too much copper increases the cost above that of a correct design. In this case an inductance of about 38 henries was chosen, giving 85 per cent. response at 60 cycles and at a cost of approximately \$1.10. Careful check on the production enabled these transformers to be held to quite close limits. A variation of plus or minus 5 per cent. was allowed as shown by the "x" marks on the response curve. The upper limit was never strictly held as this limit was seldom reached. An upper limit might be more necessary if there were danger of producing too great an a.c. hum in the output. The data on variation in cost versus the permissible variation of inductance is not complete for this transformer and will be more a function of the percentage of rejection due to errors in winding, rather than a function of design with permitted variation in mind. This is a case where too close a limit is inadvisable as the cost for maintaining reasonable limits is a very small part of the total design cost. In the case of the variable condenser a large percentage of the cost is directly attributable to the necessity for maintaining close limits.

The list of the various components and the suggested limits for the radio receiver might be continued indefinitely. Radio-frequency inductances are grouped by selection and matching. The number of groups, and closeness of matching is determined by the cost for uniformity of production, the cost of the testing and matching operation, and the variations in set performance as a result of the individual coil differences. Such balances between cost and performance are obviously necessary to build an economical set, yet are passed up because of ignorance of the effect of individual variations.

By-pass condensers, resistances, chokes, and like parts have a reason for being the values chosen. Likewise the tolerance allowable should be a proper correlation between cost and overall performance variation. No one answer can state what the limits on any part should be; the cost and criticalness of the unit make limits from $\frac{1}{2}$ to 50 per cent. justifiable as a matter of good design.

After the limits on the individual components are chosen to give the most economical design, it must be remembered that the effect on the normal receiver may be the sum of the best conditions or the sum of the worst conditions. If sufficient data is obtained and the design is correct, the sum of the worst conditions will approximate the limits as originally decided upon. Fig. 3 shows a performance curve taken upon a group of receivers. This shows the number of receivers having any given sensitivity. The actual receivers had the characteristics as shown by the solid line. The dotted line indicates the limit of sensitivity as based upon the sum of the individual components. The difference indicates the change in components due to handling, errors in original inspection or defective assembly. The limit in this case was actually set at 20 microvolts, a slight tolerance due to production idiosyncrasies. No upper sensitivity limit was set, although sensitivities as low as 5 microvolts were observed. An upper limit might be desirable if there was a tendency

(Concluded on page 120)

THE PHILCO "95" SCREEN-GRID PLUS

By **WALTER E. HOLLAND*** and **W. A. MAC DONALD†**

**Chief Engineer, Philadelphia Storage Battery Company
†Chief Engineer, Hazeltine Corporation*

DURING THE past few months the Engineering Department of the Philadelphia Storage Battery Company has been working in coöperation with the laboratories of the Hazeltine Corporation to produce a moderate-priced commercial broadcast receiver that would utilize all the advantages and overcome all possible disadvantages of the screen-grid tube. Furthermore, it was intended that this receiver embody a practical automatic volume control system of the type described by H. A. Wheeler, of the Hazeltine Corporation, in a paper he presented before the I.R.E. in November, 1927. (This paper gave data on a method using a two-element tube as a combined detector and automatic volume control in a radio receiver.) Such a receiver has been designed and was announced by Philco about September 1, 1929. It is known as the Model 95 Screen-Grid Plus.

It has been general practice in the design of receivers with automatic volume control to use an ordinary three-element tube as the detector and to employ an additional tube in the circuit to control the volume automatically. This latter tube is operated on the lower bend of its Eg-1p characteristic, its grid being excited by the output of the r.f. amplifier across which the grid-filament circuit is connected. The plate circuit of the tube is used to control the volume automatically by supplying to the control grids of the r.f. amplifier tubes a negative voltage proportional to the output of the r.f. amplifier.

Only One Rectifier

In such a circuit the automatic volume control tube is actually working as a detector, the changes in average d.c. plate current with changes in input voltage being used to supply negative bias to the r.f. amplifier grids. In the plate circuit of this tube there are, of course, audio-frequency currents, but these are bypassed to ground by means of by-pass condensers. In a sense, therefore, such sets contain two detectors or rectifiers. In one rectifier, the detector, the audio-frequency output is used to supply signal voltages to the audio-frequency amplifier and the d.c. component of plate current is not used. In the other rectifier, the automatic volume control tube, the audio-frequency components are not used and the steady d.c. component of the rectified signal is used to control the volume. Why not use a single rectifier and utilize both components of its output? This is possible and in the Philco 95 a

two-element tube (227 type with grid and plate tied together) is used to rectify the r.f. signal and to supply both an a.f. signal for the audio-frequency amplifier and a d.c. bias voltage to the r.f. amplifiers.

The two-element rectifier, when its return circuit has a high d.c. impedance, is linear over practically its entire rectification curve. In this particular receiver it is

than the time of a single cycle of the lowest audio-frequency current it is desired to amplify. Actually the control system should be designed so that its time constant (the time it takes to effect the gain) is comparable with the period of the lowest desired audio frequency. The time constant of the volume-control circuit is determined by the values of the resistance and by-pass condensers in the r.f. grid bias circuit, and in this particular receiver the time constant is about one fortieth of a second so that the circuit nearly reaches equilibrium in about one twentieth of a second. Such a value of time constant has a negligible effect on low-frequency modulation down to twenty cycles.

Tuning the Set

Automatic volume control receivers are generally rather difficult to tune by ear because the volume is essentially constant over several degrees of the dial. The more "perfect" the control system the more pronounced is this effect. This problem can be overcome either by means of a tuning meter to give a visual indication of resonance or by designing the control system so that a fairly definite peak is audible to the ear as the set is tuned through a station. After all, absolutely complete equalization of the volume is not essential (differences in the percentage modulation of different broadcasting stations will prevent any system, no matter how perfect, from giving absolutely

equal volume from all stations) and it seemed advisable to the designers of this receiver to make a slight peak apparent in the tuning so that the user of the receiver would be able to tune the set in a normal manner and not have to learn some new method of tuning, such as tuning by means of a meter. Everyone who has operated this receiver has had no difficulty in tuning it accurately to resonance by listening to the output of the loud speaker.

The automatic control is effective over a ratio of signal voltages of 300 to 1, and in combination with the local-distance switch, which gives a 40 to 1 change, complete control is obtained over a ratio of 10,000 to 1. In normal operation the r.f. input to the rectifier is about 5 volts. No better indication of the effectiveness of the volume control circuit can be had than by tuning in an average station with the "local-distance" switch in the local position, and then switching to the distance position. This changes the input voltage in a ratio of 40 to 1—and there is but a barely perceptible change in volume as the switch is

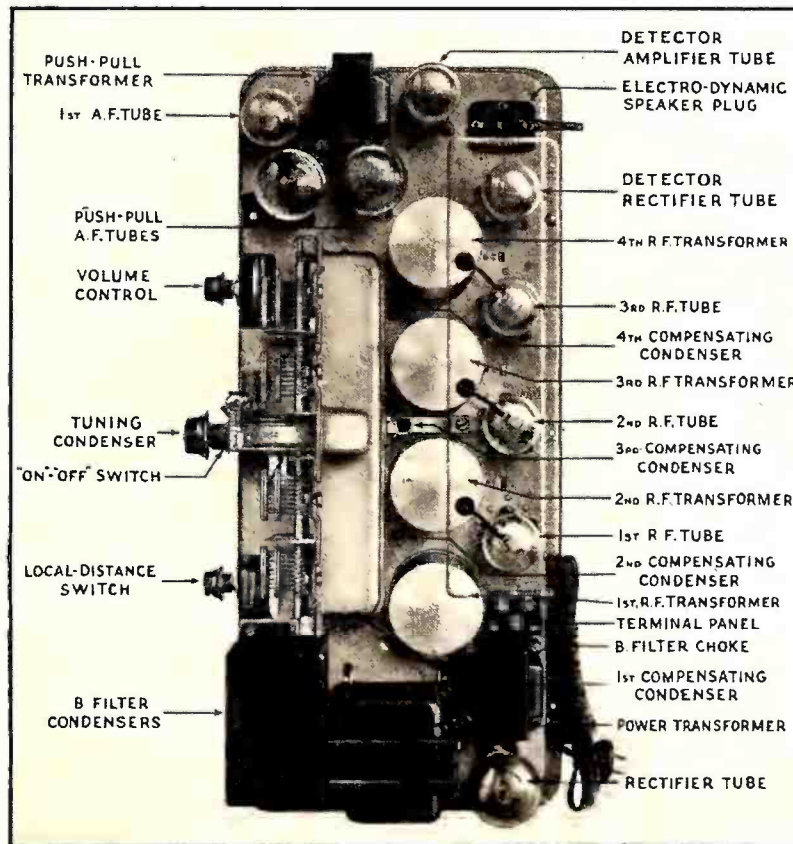

The location of all parts on the Philco 95 chassis is clearly indicated in the above picture.

linear from about 1 volt up to over 100 volts input. Such a detector gives, therefore, the much desired linear detection characteristic (unlike the three-element rectifiers which are linear over only a small part of their detection curve, the two-element tube is linear over practically its entire curve) and it is also devoid of any overloading, even at input voltages far in excess of those at which it operates in this receiver. Actually, overloading of this type of detector can be due only to operation of the tube at input voltages in excess of the maximum safe value. These properties of a two-element detector contribute to the simplicity of the system and at the same time the signal modulation is rectified without distortion.

All automatic volume control systems must be designed so that they will not seriously affect low-frequency modulation. If, for example, the control system were instantaneous in action, the control circuit would function to eliminate much of the modulation in the incoming r.f. signal. The control system should not be able to control the gain of the system more rapidly

thrown. The automatic volume control in this receiver will automatically compensate all signal fading that could be compensated by continually adjusting a manual volume control.

On the control grids of the r.f. tubes there is a steady d.c. bias of approximately 3 volts. The volume control circuit functions, of course, to increase these biases. The first two r.f. tubes receive the full grid-bias voltage available from the rectifier. However, to prevent distortion in the third r.f. amplifier stage, the third r.f. tube receives only half this bias.

The antenna circuit arrangement is interesting. In the first place the antenna primary circuit is resonant at a frequency less than 550 kc., which makes the antenna circuit tuning substantially independent of the size of the antenna—the circuit also gives a uniformly high voltage step-up over the entire band. These high inductance antenna circuits were first introduced into broadcast receivers by the Hazeltine Corporation about 1926. Since then their operation has been somewhat improved by the addition of some dead-end turns which increase the capacitive coupling between the antenna primary and the tuned secondary. The 5000 ohms which is in parallel with the antenna coil helps to reduce any periodicity of the antenna circuit and make it nearly aperiodic. The local-distance switch connects into the circuit, for local reception, a 20-ohm resistor in parallel with the 5000-ohm resistor.

Coupled Tuned Circuits

Ahead of the first screen-grid tube, two tuned circuits are used. These tuned circuits are coupled together with both the mutual inductance, *L*, and the mutual capacity, *C* = 0.015 mfd, the former predominating at the high frequencies and the latter at low frequencies. At 1500 kc. the inductive coupling is below the optimum value so that the circuits are coupled quite loosely at the high frequencies. This gives high selectivity at the high frequencies where it is so badly needed. At the low frequencies the capacity coupling is important and the coupling reaches the optimum value around 550 kc. This effectively couples the two circuits quite closely, thereby decreasing the selectivity and preventing serious sideband suppression. The combination of the two effects gives a selectivity characteristic for the antenna circuits which is quite uniform over the entire band. It will be appreciated that these two tuned circuits ahead of the first tube will effectively prevent cross talk.

The r.f. amplifier as shown by the circuit diagram (Fig. 1) employs three screen-grid

tubes. Between the first two tubes are tuned transformers which give an average gain of about 20 per stage. With the output capacity of the screen-grid tube the primaries of these transformers are resonant at a frequency slightly above 1500 kc. The gain at the high-frequency end would, with such a circuit, be expected to increase but this effect is prevented by the capacity coupling existing between the plate and grid ends of the primary and secondary coils. The capacitive coupling partly cancels the inductive coupling and prevents the gain characteristic from rising. This is not a "losser" method and therefore keeps the full selectivity.

Untuned R. F. Transformer

Because of the characteristics of the two-element detector it is preferable not to couple it to a tuned transformer. An untuned transformer is therefore used, the gain of this circuit averaging eight over the broadcast band. The 13,000-ohm resistor across the primary of this transformer damps out any resonant peaks.

There is one other point of interest regarding the r.f. amplifier. As stated previously, the capacity coupling between the first two tuned circuits is due to the 0.015-mfd condenser which is effectively in series with the tuned circuits. So that all the tuned circuits will track properly similar 0.015-mfd condensers are placed in series with the following tuned circuits, and all these three condensers are used to bypass the bias voltages.

Regarding the a.f. amplifier circuits, it will be noted that the output of the two-element rectifier is connected directly by resistance coupling to the grid of the following 227 a.f. amplifier tube. An ordinary detector functions in the dual rôle of amplifier and detector, but we have in this set two tubes that in combination do what the detector does in an ordinary set. Therefore, the two-element detector and automatic volume control circuits associated with these two tubes (the two-element detector and following amplifier) has been termed by Philco a "multiplex detector circuit." The output of the second 227-type tube of the multiplex detector circuit feeds into a resistance-coupled stage consisting of a 500,000-ohm plate resistor, a 0.015-mfd. coupling condenser and, in the grid circuit of the next tube, a 500,000-ohm potentiometer, which is the volume level control.

Volume Control Circuit

After all these years that have seen a gradual trend towards the location of the

volume control in the r.f. amplifier, it is interesting that it has once again returned to the a.f. amplifier. Probably it has returned to stay. Technically it is sound to control the sensitivity of the r.f. amplifier by means of automatic circuits designed so that there is applied to the rectifier a value of signal just sufficient to load up the power tubes when the a.f. volume control is set at maximum. The detector then works at a constant level, and the circuit can be designed so that at this particular level the detector circuit produces minimum distortion. Such principles will, we believe, be generally adopted within the next few seasons.

The 227 detector-amplifier, V5, is supplied with a value of grid bias which is a function of d.c. rectified current of the two-element rectifier. The circuit constants are such that the grid bias voltage is always slightly greater than the peak value of the a.c. signal applied to the grid. In this manner it is impossible for the grid of the tube to swing positive on the audio peaks. The sensitivity of the entire receiver is essentially constant at about 5 microvolts per meter throughout the entire broadcast band—this sensitivity is obtained, of course, with the volume control at maximum and the local-distance switch in the distance position.

Summary

In summary the features of this receiver are:

1. Two-element detector tube giving true linear detection and no overloading on signals up to 100 volts input—an input greatly in excess of that possible.
2. Automatic control of volume and fading, giving, in conjunction with the local-distance switch, satisfactory control of all field intensities in the ratio of 10,000 to 1.
3. A "multiplex detector circuit" being the name applied to the use of a two-element detector in combination with an ordinary three-element tube working as an a.f. amplifier direct connected to the output of the two-element detector.
4. A local-distance switch to prevent overloading on strong local stations.
5. Uniform-gain antenna and interstage coupling circuits to maintain a constant sensitivity of about 5 microvolts per meter throughout the broadcast band.
6. Simplicity of operation—the manual volume control need be touched but seldom.
7. Excellent fidelity due to the linear and non-overloading detector together with the resistance-coupled first a.f. stage and a push-pull power stage.

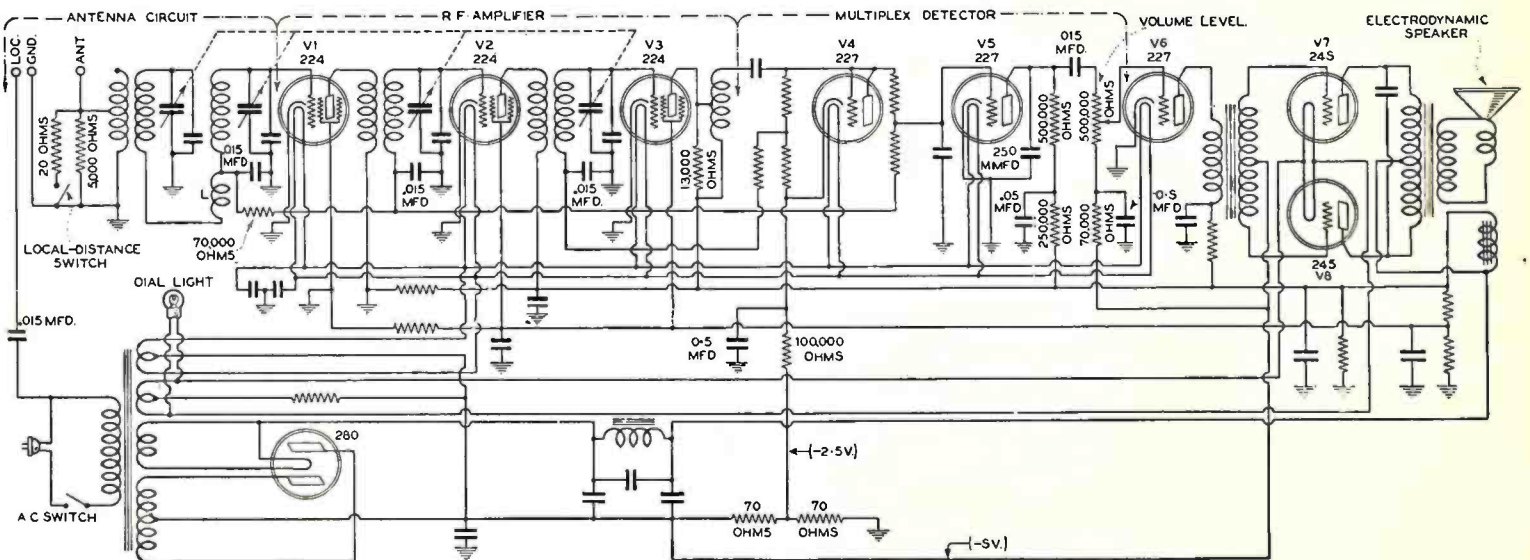

Fig. 1—Complete schematic diagram of the Philco 95 receiver.

THE ELECTRODYNAMIC LOUD SPEAKER

By EDWIN A. UEHLING

THE ELECTRODYNAMIC loud speaker has the unique characteristic of being capable of extremely simple mathematical treatment. It is possible to develop equations which show the importance and the exact nature of nearly every factor that has an influence on the performance of the loud speaker. These equations will be found useful not only in the actual design of loud speakers using the electrodynamic principle, but also as a foundation for experimental research on this type of reproducer.

The equations under discussion are not as complicated as are those which deal with the electromagnetic and some other types of loud speakers because there are fewer variables to consider. The permanent magnetic flux of the field, for example, is invariable, and enters directly into the final equations. The magnetic flux of the signal current is at right angles to this flux, whereas in the electromagnetic type it adds directly to the flux of the field. Saturation problems hardly enter as far as distortion is concerned, and are not at all difficult of solution as far as efficiency is concerned. The flux density of the field enters into the force factor equations as a first power rather than as a second power thus giving us another possible simplification.

The Electrodynamic Principle

The electrodynamic principle is understood to refer to the reaction between a conductor carrying an electric current and a magnetic field in which this conductor is immersed. The electrodynamic loud speaker has these two elements, the conductor and the magnetic field, and a third element consisting of some radiating device for transmitting the mechanical reaction between the conductor carrying the signal current and the electromagnetic field to the surrounding air.

First of all it will be necessary to understand the importance of all factors which have a bearing on the efficiency of the loud speaker. In this connection it should be pointed out that the efficiency of a loud speaker is understood to refer to the ratio of the actual power delivered to the armature, represented by the product of the square of the signal current and the motional resistance, and the electrical power delivered to the loud speaker. Thus we leave out of consideration, temporarily, any loss of energy which may exist in the system between the armature and the surrounding air. This loss of energy may or may not be considerable, depending on the design of the radiating system, which will be discussed later. This is a problem belonging to the mechanical system itself, and, with the exception of the term representing the actual mechanical impedance, need not be considered in the development of the equations for the efficiency of conversion of electrical into mechanical energy.

The electrodynamic unit may be considered as a motor which converts the energy of electric currents into mechanical energy, and in so doing develops a counter e.m.f. that is easily calculated, and upon which a complete understanding of the

performance of the loud speaker quite largely depends.

The e.m.f. generated in a conductor which is cutting lines of force is equal to—

$$e_c = \frac{d\theta}{dt} \cdot 10^{-8} \quad (1)$$

Now the rate at which the conductor in the moving-coil system of an electrodynamic unit cuts the lines of force of a magnetic field threading through this coil is equal to the product of the length of the conductor in centimeters, the velocity of the conductor in centimeters, and the flux density of the field. Then—

$$e_c = \frac{d\theta}{dt} \cdot 10^{-8} \quad (2)$$

$$= l v B \cdot 10^{-8} \quad (3)$$

The velocity of the moving coil is given as the ratio of the force imparted to the coil and the complex mechanical impedance. Then—

$$v = \frac{F}{Z_m \angle \alpha} \quad (4)$$

$$e_c = \frac{F}{Z_m \angle \alpha} l B \cdot 10^{-8} \quad (5)$$

The force in dynes given to the moving coil is equal to the product of the length of the conductor, the current passing through it in c.g.s. units, and the flux density.

$$F = l c B \quad (6)$$

$$= l l B \sin \theta \cdot 10^{-1} \quad (7)$$

then
$$e_c = \frac{l l B \sin \theta \cdot 10^{-1}}{Z_m \angle \alpha} l B \cdot 10^{-8} \quad (8)$$

$$= \frac{l^2 B^2 \cdot 10^{-9}}{Z_m \angle \alpha} \sin \theta \quad (9)$$

Then the resistance due to the counter e.m.f. is

$$R_c = \frac{l^2 B^2 \cdot 10^{-9}}{Z_m \angle \alpha} \quad (10)$$

If R_1 is the d.c. resistance of the coil, or more exactly the clamped apparent resistance of the coil, and L_1 is the apparent clamped inductance of the coil under its conditions of use, the total electrical impedance is—

$$Z_e = R_c + R_1 + j \omega L_1 \quad (11)$$

$$= \sqrt{R_c + R_1)^2 + \omega^2 L_1^2} \quad (12)$$

$$= \left[\frac{l^2 B^2 \cdot 10^{-9}}{Z_m \angle \alpha} + R_1 \right] + j \omega L_1 \quad (13)$$

Let

$$Z_m \angle \alpha = a + j b \quad (14)$$

where

a = mechanical resistance of system

b = mechanical reactance of system

then

$$Z_e = \left[\frac{l^2 B^2 \cdot 10^{-9}}{a + j b} + R_1 \right] + j \omega L_1 \quad (15)$$

$$= \left[\frac{l^2 B^2 (a - j b) \cdot 10^{-9}}{Z_m^2} + R_1 \right] + j \omega L_1 \quad (16)$$

$$= \left[\frac{a l^2 B^2 \cdot 10^{-9}}{Z_m^2} + R_1 \right] + j \left[\omega L_1 - \frac{b l^2 B^2 \cdot 10^{-9}}{Z_m^2} \right] \quad (17)$$

This equation shows that for frequencies below the resonant frequency of the mechanical system, where b is negative, the apparent or free reactance is greater than the actual or clamped reactance, and that the apparent resistance is always larger than the actual resistance. The importance of the term in the first bracket,

the real term of Z_e , will be shown. Let us note in passing that the motional resistance which is equal to—

$$R_m = \frac{a l^2 B^2 \cdot 10^{-9}}{Z_m^2} \quad (18)$$

is never negative as in some other types of loud speakers. However, this fact might have been established without considering these equations. The force, the signal current, and the flux due to the signal current are all practically in the same phase; whereas, in the electromagnetic type of loud speaker, for example, the flux due to the signal current, and therefore the force, lags the current by the hysteresis and the eddy-current angle.

The efficiency of conversion of electrical to mechanical energy is now easily determined. The actual power delivered to the moving system is equal to

$$W = I^2 R_m \quad (19)$$

where I is the signal current in the conductor of the moving coil, and R_m is the motional resistance. But—

$$I = \frac{\mu E_g}{\sqrt{(R + R_p)^2 + X^2}} \quad (20)$$

where

$$R = R_m + R_1 \quad (21)$$

R_p is the plate resistance and

$$X = j \left[\omega L_1 - \frac{b l^2 B^2 \cdot 10^{-9}}{Z_m^2} \right] \quad (22)$$

then

$$W = \frac{\mu^2 E_g^2 R_m}{(R + R_p)^2 + X^2} \quad (23)$$

Now the power input to the moving coil is:

$$W_1 = E I \cos \theta \quad (24)$$

$$= \frac{\sqrt{R^2 + X^2}}{\sqrt{(R + R_p)^2 + X^2}} \mu E_g$$

$$\cdot \frac{\mu E_g}{\sqrt{(R + R_p)^2 + X^2}} \cdot \frac{R}{\sqrt{R^2 + X^2}} \quad (25)$$

$$= \frac{\mu^2 E_g^2 R}{(R + R_p)^2 + X^2} \quad (26)$$

Then the efficiency E is

$$E = \frac{W}{W_1} \quad (27)$$

$$= \frac{\mu^2 E_g^2 R_m}{(R + R_p)^2 + X^2}$$

$$\frac{(R + R_p)^2 + X^2}{\mu^2 E_g^2 R} \quad (28)$$

$$= \frac{R_m}{R} = \frac{R_m}{R_m + R_1} \quad (30)$$

We will substitute for R_m and R their values as given in the equation for Z_e

then

$$E = \frac{a l^2 B^2 \cdot 10^{-9}}{Z_m^2} \cdot \frac{1}{\left[\frac{a l^2 B^2 \cdot 10^{-9}}{Z_m^2} + R_1 \right]} \quad (31)$$

$$= \frac{a l^2 B^2 \cdot 10^{-9}}{a l^2 B^2 \cdot 10^{-9} + R_1 Z_m^2} \quad (32)$$

It is then evident that for maximum efficiency the quantity

$$\frac{a l^2 B^2 \cdot 10^{-9}}{Z_m^2}$$

should be as large as possible

There are certain obvious conclusions that can be drawn from the above statement regarding, for example, the quantity B , the quantity Z_m , and the value of a in comparison with the total impedance Z_m : i.e., the effect of mechanical resonance on the efficiency.

Other Conclusions

There are still other conclusions that may be drawn. In the design of an electrodynamic loud speaker, a very limited proportion of the cross-sectional area of the air gap can be given to the copper comprising the conductor. The air gap spacing is limited by the maximum reluctance permissible in the magnetic circuit for the magneto-motive force available and the flux required. The width of the gap is limited by the requirements of economy in design, for it is only at the air gap that an approach to magnetic saturation in the iron can be permitted. At all other points in the magnetic circuit the cross-sectional area should be considerably larger than at the air gap to avoid saturation in these parts. Thus the maximum amount of iron intended for use in the circuit is one of the limiting factors in determining the maximum width of the air gap. Finally, with an air gap cross-section, or to be more exact, an air gap volume determined by these and other factors to be described later there is a definite maximum volume of copper that can be used for the conductor carrying the signal current. This volume of copper is further reduced by the requirements of spacing between the coil form and the inner and outer pole faces and by the necessary thickness and volume of the coil form or support itself.

With our copper volume limited in this way, there is only one condition left that is variable. That condition is in the choice of wire. For a given volume of copper an increase in the size of the wire used means a decrease in d.c. resistance and a decrease in the number of turns. As a matter of fact, the ratio of the square of the total length of the conductor required to fill a given volume, to the d.c. resistance of the conductor, and therefore to R_1 , is a constant and depends only on this volume.

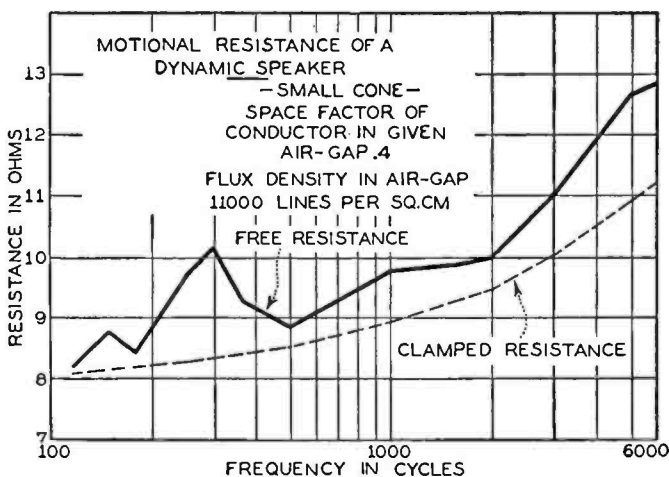

The slight change that there is in the space factor with different sizes of wire is neglected. This ratio being a constant, we learn on further reference to the equation expressing the efficiency that there is nothing to be gained by increasing the length of the conductor. One turn or many turns may therefore be used as desired, provided that a suitable impedance-matching transformer is always used.

Using one turn of heavy copper conductor in the air-gap has the advantage of simplicity, greater space factor, and a greater volume of copper than could otherwise be obtained. Using many turns has

the advantage of greater freq resistance with the result that other resistances, such as those of the loud speaker connecting leads, become less important. Many turns also have the advantage of permitting a more desirable mechanical construction. It is not necessary when many turns are used to have the moving system and the entire cone swing about an asymmetrical axis as is so often done in loud speakers using but one turn of heavy copper for the moving coil.

The Electromagnet

The magnetic field of the air gap is usually supplied by means of an electromagnet. This magnet consists in general of a central iron core and an enclosing iron shell with a flat iron cover to complete the circuit and to provide a circular gap. There are many other methods in use. Any construction that minimizes as far as possible the amount of iron required, and yet provides sufficient cross section at all points to carry the flux in the gap as well as the total leakage flux, is good. The metal used should be a good soft grade of steel. Though the reluctance is quite largely localized at the air gap, the reluctance in the iron must be considered as well. Even with good grades of steel tests have shown a marked

improvement with annealing, indicating that considerable attention should be given to the iron in the magnetic circuit. If the flux path is cylindrical in shape usually no trouble will be experienced with saturation except at the lower end of the core where it is attached, and at the upper end of the core, where saturation is often permitted in order to reduce leakage flux from the core to the cover across the air gap. However, saturation should not be permitted except at the pole faces. Even when the cross section of the core is increased near the upper end, there may be an increase in the flux density as well. At the lower end of the core an additional iron plate that has a diameter somewhat less than that of the cylinder of the electromagnet itself should be used to avoid saturation in this region. Finally, all butt joints should be as close as possible to eliminate added reluctance.

Due to the high leakage flux that always exists it is impossible to determine with great accuracy the flux density that a given set of conditions will provide. One example of how large this leakage flux was is typical of many such designs. In this particular case the total flux passing through the lower end of the core was 72,000 lines. The number of lines of force in the air gap, measured across the actual geometric width of the gap, was less than 45,000. Fringing directly beneath the gap there were about 15,000 lines, and directly above the gap there were about 11,000 lines.

With a knowledge of these conditions it is possible to make use of magnetic circuit equations, allowing for the leakage flux in the calculation. It will be assumed that

good iron is used throughout the magnetic circuit. The reluctance of the circuit is then very nearly—

$$R = \frac{l}{A} \tag{33}$$

where l is the length of the air gap in centimeters, and A is its area in the same unit squared.

A satisfactory flux density in the air gap is about 12,000 lines per square centimeter. A higher flux density may be desired but can be obtained only by increasing the cost. The first named figure, however, is very often the highest that can be obtained economically in an air gap of conventional design. The product of the flux density and the area of the air gap gives us the total flux in the gap.

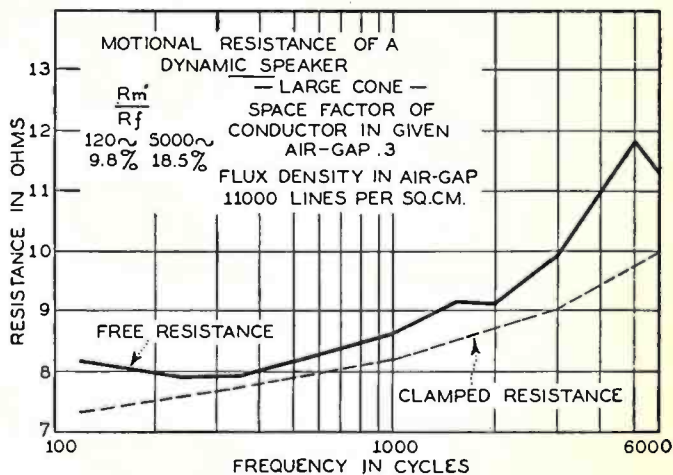

Then, taking the product of the flux and the air gap reluctance, we obtain the magneto-motive force in gilberts required to force this flux through the gap.

$$MMF = \varphi R \text{ gilberts} \tag{34}$$

$$= .4 \pi NI \tag{35}$$

then

$$NI = \frac{\varphi R}{.4 \pi} \text{ ampere turns} \tag{36}$$

When the value of the required ampere turns is known the coil of the electromagnet can be designed according to well-known principles. The value of N will depend on the nature of the source of current. If the coil is to be used as a filter choke coil of a power supply system, N will be very large and may amount to 20,000 or 40,000 turns. Under these conditions the voltage drop in the coil will usually be made as large as the supply will permit; i.e., all of the surplus voltage is used to supply the field. This is necessary to permit the use of wire as small as possible. The smaller the size of wire used, the smaller the field coil and the associated magnetic circuit will be. In most practical cases the limit to any great reduction in the size of the wire depends upon the maximum value of the d.c. voltage available. Other limiting factors are the difficulty of winding small sizes of wire, and the maximum permissible power dissipation in the coil. The latter factor is in many practical cases the controlling one, especially when the loud speaker is intended for use in a small cabinet in which there is not much air circulation. In general, this power dissipation for coils and iron containers of the size now in commercial use can be as much as twelve to twenty watts.

Reference has been made to the high value of leakage flux usually present in magnetic circuits of this type. This flux should be estimated on the basis of experience and added to the useful flux of the air gap whenever the flux carrying capacity of the constricted portions of the

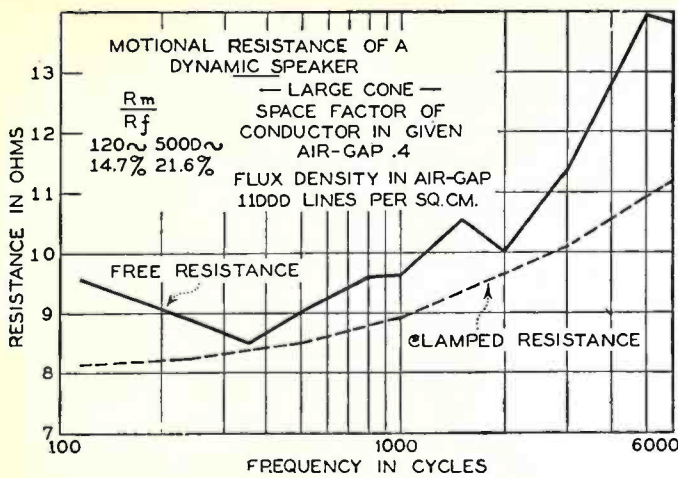

magnetic circuit is considered. It does not, however, enter into the calculation of the M.M.F. to any large extent, because it forms a parallel flux path to that of the useful magnetic flux, which, therefore, has its own magnetic flux-reluctance drop around the circuit as in electrical circuits.

Sound Radiating Device

We will now give some consideration to the sound-radiating device. This usually consists of a paper cone supported around its periphery and attached directly to the coil form. Our equation for efficiency shows that Z_m , the mechanical impedance, should be made as small as possible to give a high ratio of conversion of electrical to mechanical energy. This energy must, however, be radiated, and a small diaphragm, having a lower acoustic impedance than a large diaphragm is not capable of radiating energy to the air as efficiently as the latter. Of the two transformations of the energy resident in the signal current, the latter (the mechanical to acoustical transformation) is by no means the least important. Increasing the size of the radiating member will increase the value of Z_m over most of the frequency range, and thereby reduce the efficiency of the transformation of electrical to mechanical energy; but an increase in the efficiency of the transformation of mechanical to acoustic energy will be obtained, and the resultant overall efficiency will not be altered greatly.

The design of the radiating member has a very direct bearing on the quality of reproduction. There will be present several resonant frequencies having various degrees of damping. The number of these frequencies and the resistance factor involved can be altered materially in the design. Increasing the size of the cone increases the length of the path that the wave energy must travel. There are two principal consequences. The resonant frequencies are lowered, and many that would otherwise be important are placed below the lowest frequency to which the ear is sensitive. The remaining resonant frequencies are materially damped by the increase in the length of the path which the wave motion must follow.

Large Cone Best

For these reasons the large cone is usually capable of better quality of reproduction than the small cone. The fact that it also gives better low-frequency response need not be emphasized, though, it is true, that the amplitude of vibration of which the electrodynamic loud speaker is capable is so large in comparison with the maximum amplitude of vibration

given by other types that we are inclined to overlook the advantage of the large cone as far as low-frequency reproduction is concerned. Yet, a very decided mechanical advantage remains, for the amplitude of vibration necessary to produce a given acoustic output is approximately proportional to the inverse square root of the area of the cone, and the maximum flexure of the supporting members is reduced as the area of the cone is increased. Experimental data has shown that a diameter of twelve to sixteen inches gives entirely satisfactory results. Increasing the diameter above these values does not usually produce a corresponding increment in quality improvement. On the other hand, further increase in the size of the cone does add considerably to the cost and inconvenience in the mechanical construction of the loud speaker.

Among the most important of all the design features of paper cones is the value of the interior angle at the apex. It is obvious that a relatively small angle tends toward greater stiffness, a better approximation to plunger action, and

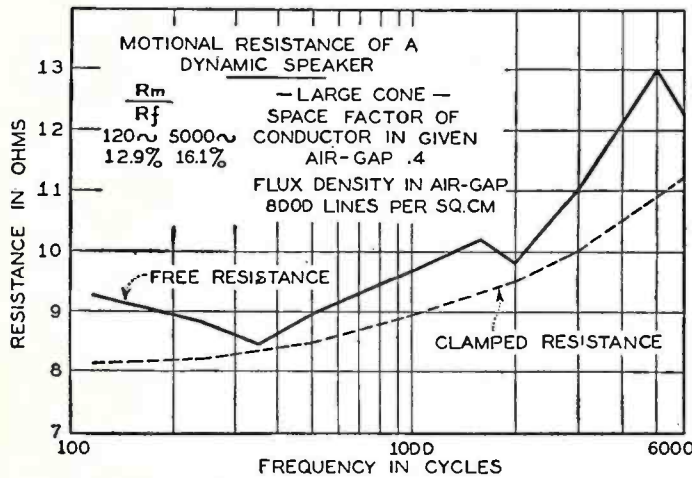

perhaps greater efficiency. Nevertheless it also tends toward the introduction of numerous resonant frequencies, at least one of which may predominate in the reproduction above all other audio frequencies. A relatively large angle tends toward more uniform wave motion at all frequencies, lower and fewer resonant frequencies, especially if the diameter is large, and perhaps reduced efficiency. In most cases this angle must be determined experimentally, and will depend on the material used, the size of the cone, and on the method of measuring or judging the relative characteristics.

If the final design depends on actual measurement the interior angle will probably be made relatively large. If it depends instead on listening tests, the angle will usually be made relatively small, for the ear is often deceived in such tests, and is inclined to favor reproduction that has at least one resonant frequency conveniently placed in the lower-frequency spectrum so as to hide certain faults in the reproduc-

tion, and to lend a greater warmth of color than is present in the original transmission. The tendency now is toward more faithful reproduction of the original, and there is consequently a trend from small angle cones to the large angle or more shallow types. A second trend which is toward the larger diameter is also current. These tendencies may culminate in a more or less general design of cone having a diameter of at least twelve inches and a value for the interior angle at the apex of approximately 140°. Actual acoustic measurements show that such a design is good, and that it has, at least, no decided superiors, providing that a good grade of paper or other material is used.

Material Used in Cone

The material of which the cone is made has a very decided influence on its acoustic performance. It is essential that the material be relatively non-resonant; i.e., one having a high molecular resistance. Though materials of this kind do not give the maximum in efficiency they are far superior in other respects. The property of non-resonance belongs to materials of this kind by virtue of their texture, which is more or less porous and fibrous. Other materials having the same property are made up of interwoven strands.

Before leaving the subject of materials something should be said regarding their weight and thickness. It is important, of course, that all moving masses be as low in value as it is possible to make them. It is also true that the weight of the cone makes up a large percentage of the total mass. But in most cases satisfactory quality of reproduction does not permit the use of extremely light weight material. The choice of the material should rest on the results of experimental tests.

The design of loud speakers is most rapid and successful when every step is carefully checked and tested in the laboratory. The very nature of acoustic problems, the psychological element involved, and the many interpretations that may be placed on the data obtained in the laboratory call for very careful and consistent experimental work. It is probable that some of the principles discussed here may be useful in aiding continued experimental work on the electrodynamic loud speaker, which, in spite of certain limitations, is perhaps the most faithful in signal reproduction of all the types of sound reproducers. There is, furthermore, little doubt that it is capable of still further improvement and refinements, and this, it is hoped, the continued work of many engineers will give to it.

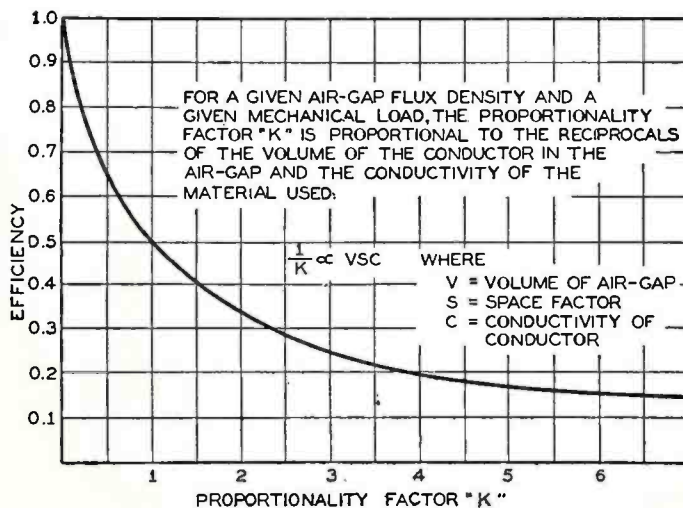

DEVELOPMENT OF THE PENTODE TUBE

BY FRIEDRICH OSKAR ROTHY

Chief Engineer, Philips Radioröhren, G. m. b. H., Vienna

IT IS necessary that the output tube of a modern radio receiver furnish considerable power to the load into which it works—the loud speaker. It is also desirable that considerable amplification take place in this tube. However, usual tubes deliver the power at the expense of amplification, because they are almost invariably of the low-mu, low-resistance type.

By the construction of three-grid tubes in Europe (Philips B-443) with very great spacing, it has been found possible to raise the mu to 100, and to maintain the power output at a high level. In other words, the use of three grids makes possible the construction of a power tube with high output and high amplification.

It is well known that due to the electron emission from the filament a space charge of a cloud of negative electrons is formed. These negative charges make it more difficult for the other electrons to leave the filament, and in addition they apparently reduce the plate voltage by their own potential.

Although this so-called space charge can be overcome by increasing the plate voltage, practically there is a limit, in the case of receiving tubes, beyond which this can not be done.

The Second Grid

It is a relatively recent discovery that the space charge can be reduced by introducing a second grid into the tube. This principle is employed in the construction of the normal double-grid (space grid) tube. In this case it is possible to reduce the plate voltage greatly and still have normal plate current. (See Fig. 1.) The auxiliary grid of this double-grid tube is placed between the cathode and the exciting grid, and the positive voltage applied to it is sufficiently high to reduce the space-charge effect.

A second difficulty encountered in the construction of radio tubes is the so-called plate-reflex effect. This limits the maximum undistorted energy that a tube can give. Considering the effects of space charge, with a constant filament temperature, the emission is a function of the filament voltage. Assuming a resistance

load in the plate circuit, which at the same time does not have any direct-current resistance, such as would be the case in an anti-resonant circuit, it is obvious that the plate voltage is the same as the battery voltage only so long as there is no alternating voltage on the grid. Therefore, we must understand that the plate voltage is the real voltage produced between the plate and filament, which is less than the battery voltage, as shown in Fig. 2. If the grid goes more positive, the plate current increases and there is a drop in the external resistance, R_a , due to this increase. This opposes the plate voltage, so that the voltage on the plate is no longer equal to the battery voltage. Similar effects are present when the grid is made more negative.

The reflex action of the plate which is described above naturally causes a decrease in the swing of the plate current. This is the reason for the often repeated rule governing the use of tubes in practical circuits which states that the tube does not work on the same characteristic curve when it is loaded as when it is worked into a short-circuit. In other words, the dynamic characteristic is not the same as the static.

Reducing Plate-Reflex Effect

Inasmuch as the dynamic characteristic always shows a smaller slope than the static, it is necessary to know this characteristic of the tube when worked under average conditions. There is a second requirement, therefore, in the construction of a radio tube, i.e., to reduce the plate-reflex effect, so that the dynamic characteristic may be as near to the static as possible. With such a tube considerable output can be obtained with a value of alternating grid voltage that produces only a small amount of power from a conventional tube.

If now, in accordance with Fig. 3, a second grid is inserted between the normal exciting grid and the plate, and a positive voltage is applied to it, the plate-reflex effect is compensated to a greater or lesser extent. This second grid will have a constant positive voltage with respect to the filament irrespective of the external resistance, R_a . Also, if a voltage drop is experienced in the plate circuit, due to the effect of the second grid, the effective voltage will not be reduced.

Under these conditions it is obvious that from time to time the auxiliary grid will be at a higher positive potential than the plate. This fact can cause a phenomenon which may be described as follows. It is well known that secondary electrons can be produced by bombardment of the plate. The bombardment usually, as in the case of transmitting tubes, merely produces heat at the plate. However, the dissipation of the energy produces the second phenomenon of secondary electrons. In the usual tubes, they merely fall back on the plate, since the field is directed only towards the anode. In the

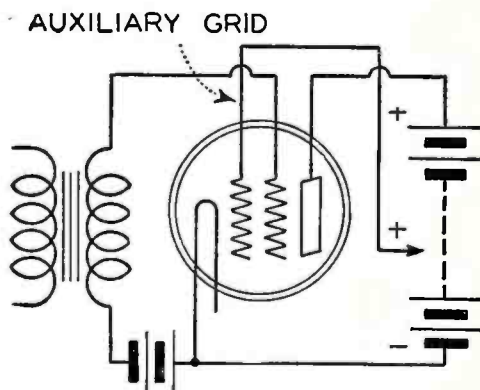

Fig. 1

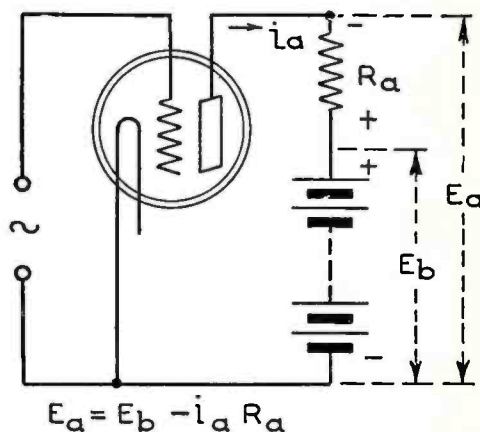

Fig. 2

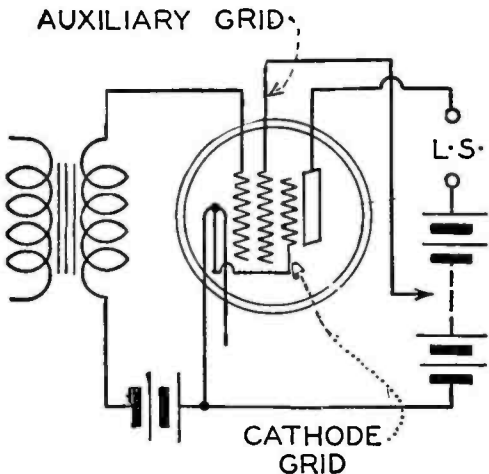

Fig. 3

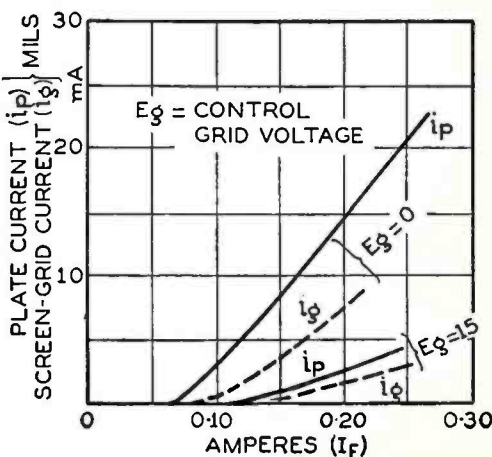

Fig. 4

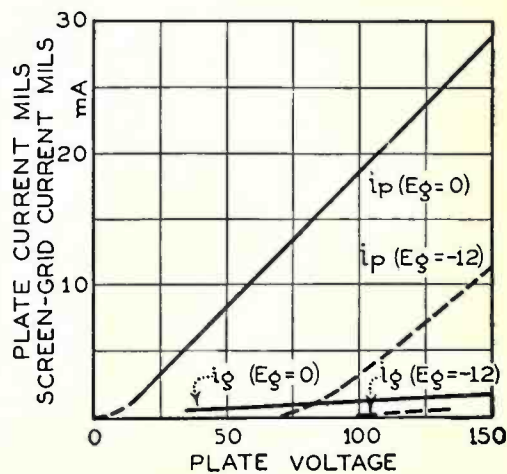

Fig. 5

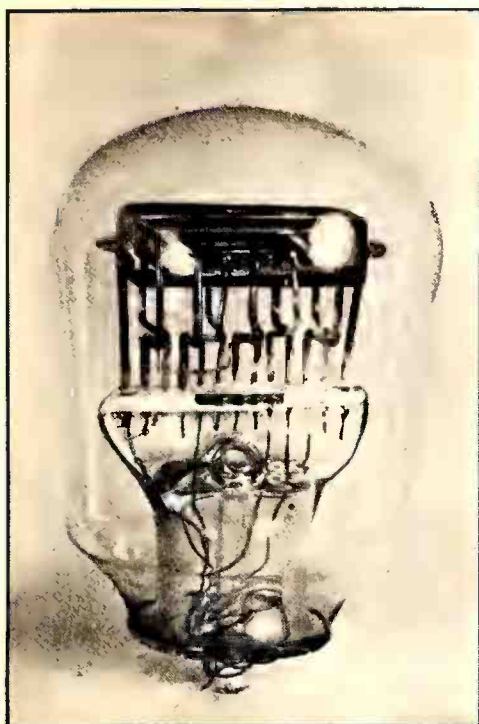

Fig. 6

practical case, therefore, there will be no effect due to the secondary electrons aside from the heating of the plate, as long as the plate is at the highest potential. And this is actually the case in the usual uses of the tube.

In measurements where a higher voltage is impressed on the grid to carry the characteristics beyond the usual range, it is found that after the saturation current is reached, the emission is no longer constant but greatly increases with higher positive plate voltages. In this case, the electrons wander from the plate to the grid and, as a result, are in the opposite direction to that of the normal emission of the filament. They therefore subtract from it and give the apparent effect that the plate current decreases. The secondary emission comes into the question, then, whenever there is another electrode in the tube which has a positive voltage applied to it. In the double-grid tube, due to the external voltage drop, the plate frequently has a lower voltage than the auxiliary grid. In this case, the secondary electrons will travel to the point of higher potential—that is, to the auxiliary grid—and as a result, in the upper part of the emission curve the functioning of the tube will be affected.

A means must be devised to take care of these secondary electrons when the plate

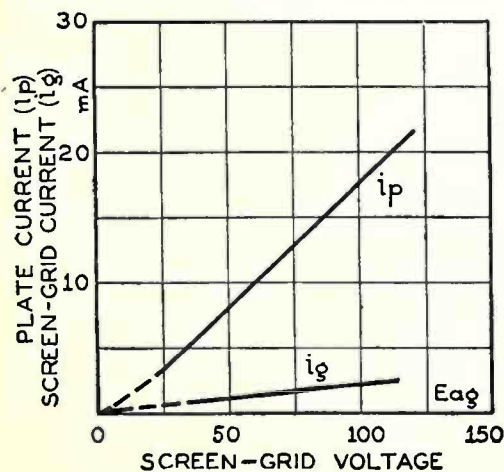

Fig. 8

voltage is less than the auxiliary grid voltage. This can be done by the insertion of a third grid, the so-called cathode grid. This is put in between the plate and the auxiliary grid and has a somewhat lower potential. Therefore, the secondary electrons find themselves in a field directed towards the plate, since they prefer to go to the plate rather than to the cathode grid with its lower potential. As a result, the secondary electrons fall back into the plate and do not affect the operation.

A very interesting feature of the three-grid tube is the apparent improvement of reproduction at the higher frequencies. The high internal resistance, about 50,000 ohms, can be neglected in comparison with the resistance of the loud speaker at the higher frequencies. The loud speaker, of course, has a dropping frequency characteristic at the upper end of the audio range. The three-grid tube, due to its higher internal resistance, is the only tube which tends to give better reproduction of the higher frequencies and therefore a more even result over the whole range. Practically this is of no advantage, since usually the bass is preferred in a loud speaker, as is the case in an electrodynamic type. In the use of electrodynamic loud speakers, however, the three-grid tube has an advantage due to the more natural reproduction.

[It must be remembered that the author is speaking from the Continental viewpoint when he discusses fidelity of re-

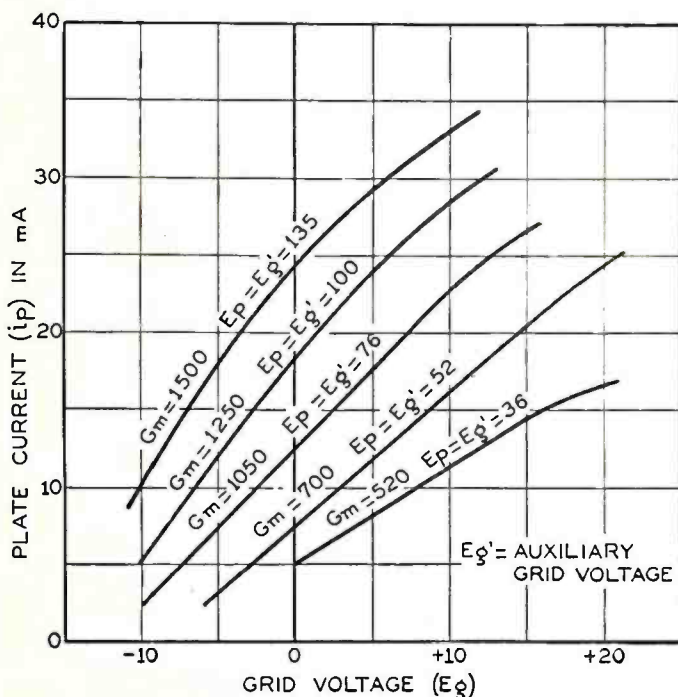

Fig. 10

production. Of course, it is possible to "match" any tube to any load with the proper transformer and thereby secure the desired characteristics.—*The Editor*]

Measurements

In the following paragraphs are the results of our measurements on a three-grid tube of the type described. A tube was connected as it is usually used in present loud speaker practice (See Fig. 3). The internal construction of this tube is shown in Figs. 6 and 7.

Fig. 4 shows the relation between filament current and emission for a grid voltage $E_g=0$ and $E_g=-15$, as well as (i_s) between filament current and screen-grid voltage (i_g). It will be noted that the value of the screen-grid current is about 16 per cent. of the total load current from the plate current source. These curves correspond to the normal temperature

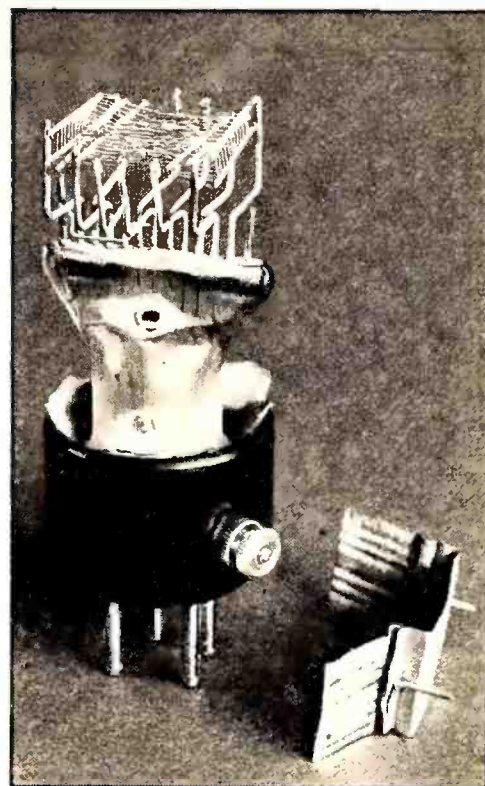

Fig. 7

emission curves; the screen grid can be considered as a part of the plate.

Fig. 5 shows the relation between plate voltage and emission to the screen grid and plate for two different screen grid voltages. In this case also, the screen grid takes about 16 per cent. of the load current. The measurements were carried only as high as 150 volts and at this voltage the saturation point had not yet been reached. Filament temperature was constant in these measurements, and the auxiliary grid was at the same potential as the plate.

In the measurements of Fig. 8, the auxiliary grid voltage was varied and the plate voltage held constant at 135 volts. The emission and auxiliary grid current increase rapidly with increase of the auxiliary grid voltage. This voltage should therefore be as high as possible, even higher than the plate voltage itself. Even the slope of the characteristic depends to a large extent on the auxiliary grid voltage. It increases, as shown in Fig. 9, with an increase in the auxiliary grid voltage. The plate voltage was held constant at 135. The curve in Fig. 10 was derived on the assumption of a normal characteristic for the different values of the auxiliary grid voltage. It can be seen that not only the emission but the steepness decreases with decreasing plate voltages.

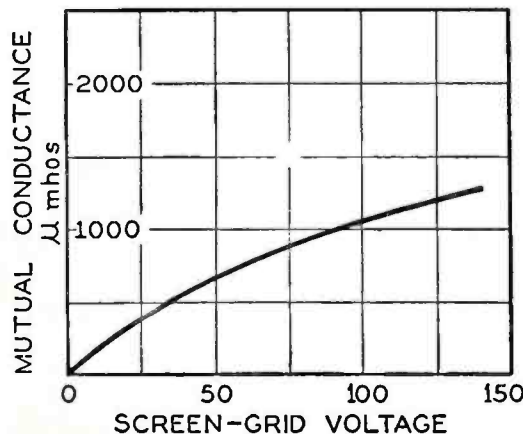
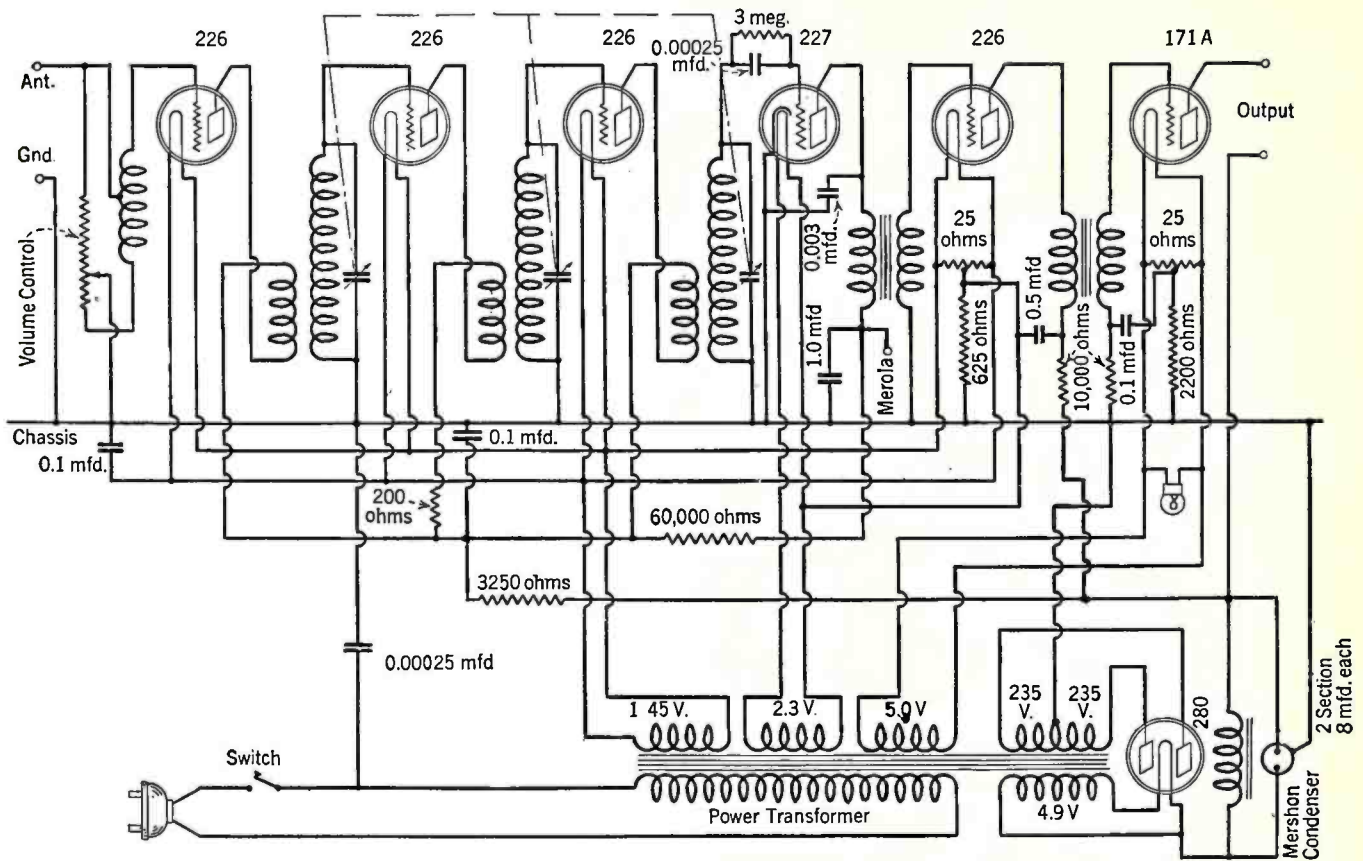

Fig. 9

CROSLY GEMCHEST MODELS 609 AND 610



This is a conventional tuned radio-frequency receiver using a grid-leak-condenser detector and two stages of audio-frequency amplification. The output tube is a single type 171A. Plate voltage

is obtained from a 280-type full-wave rectifier the output of which is filtered by a choke in combination with a Mershon condenser. The volume control is a variable resistor across the antenna circuit.

DAY-FAN MODEL 5091 RADIO RECEIVER

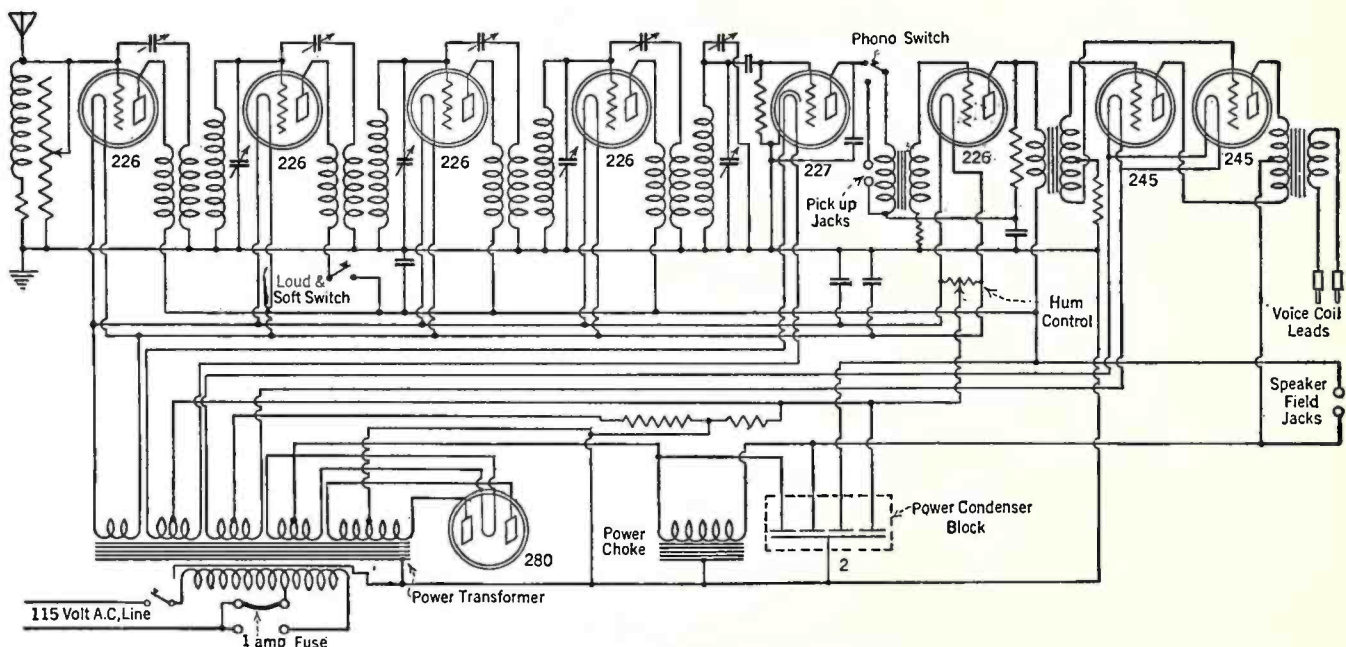

This Day-Fan receiver incorporates four balanced tuned stages of radio-frequency amplification, a semi-tuned input system, detector, one stage of straight audio-frequency amplification, and one

stage of push-pull audio-frequency amplification. In the output are two 245-type tubes. Power for the electrodynamic loud speaker field is obtained from the filter system.

TRIAD Insured RADIO TUBES



Ask for the tube in the black and yellow triangular box"

Unlimited
POWER
without
Distortion.

TRIAD INSURED RADIO TUBES are manufactured in a plant equipped with the most modern machinery known. The technical skill and special processes which produce TRIAD Tubes allow unlimited power that retains all the truth and beauty of the original tone. When a tube combines such a feature with a printed certificate guaranteeing a minimum of six months' perfect service, it must be good—tube purchasers realize it. That's why dealers are enjoying greater profits with TRIADS than they have ever experienced before.

Tune in on the TRIADORS every Friday evening, 8 to 8:30 (Eastern Standard Time) over WJZ and associated NBC Stations.

TRIAD MFG. CO., Inc.
Pawtucket, R. I.

TRIAD INSURED RADIO TUBES

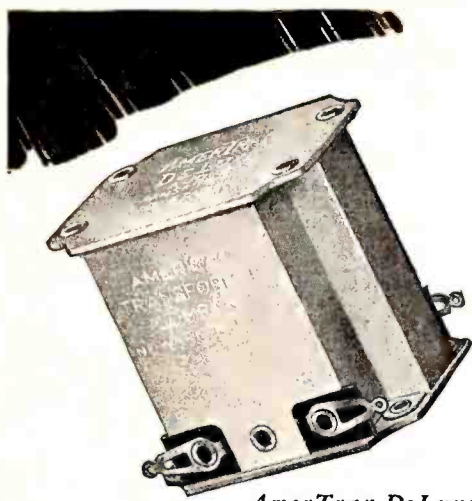

AmerTran De Luxe Audio Transformer—List Price \$10.00. Type 151—Between one input and two output tubes—List Price \$15.00



Type AF-8 Audio Transformer—Either 1st or 2nd stage audio—Turn ratio 3½—List Price \$6.00

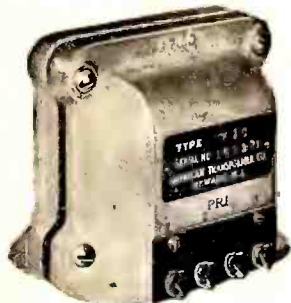

Type 710 Audio Transformer—Between two input and two output tubes—List Price \$20.00

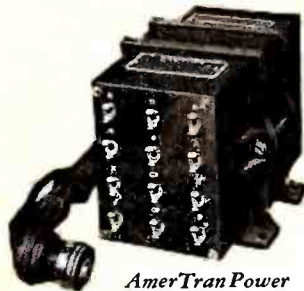

AmerTran Power Transformer—Type PF-245A—List Price \$22.00



Bring the Studio to your Home

There is no excuse for imperfect radio reception. But even today, receiving sets fail to reproduce music and the speaking voice in true tone identical with the range of pitch and the rich fulness of sound quality as broadcast in the studio.

The weak point in most receiving sets is in the audio system.

AmerTran Audio Transformers and Power Transformers shown here perfect the audio system and bring the programs into your home exactly as they go over the air through the microphone. For further descriptions of these and thirty-odd products in the field of radio reproduction that have attained the perfection necessary to AmerTran Standard of Excellence, write for Bulletin 1065.

The facilities of our engineering department are at the service of everyone interested in better radio reproduction.

AMERTRAN

TRADE MARK REG. U.S. PAT. OFF.

QUALITY RADIO PRODUCTS
AMERICAN TRANSFORMER COMPANY
Transformer builders for over 29 years
178 EMMET STREET, NEWARK, N. J.

AMERICAN TRANSFORMER CO.
178 Emmet St., Newark, N. J. RB-12-9
Please send me Bulletin 1065 containing complete information on AmerTran Transformers, for better radio reception.

Name
Address

Frequency-Band Requirements

ON SHEET No. 308 is reproduced a chart taken from an article by B. S. Cohen in the March, 1928, *Proceedings of the Institute of Electrical Engineers*, London. The chart shows eleven octaves of sounds. According to this chart we find that the

- (a) Ideal frequency range for perfect speech and music and most noises is 30 to 10,000 cycles
- (b) Reproduction of high-quality speech and music requires a frequency band from 100 to 5000 cycles
- (c) Reproduction of good quality articulate speech requires a frequency band from 200 to 3000 cycles

Considering the reproduction of music, on reference to the chart it will be noted that the highest note of the organ, C⁶, has a frequency of 8000 cycles so that if the ideal band extends to 10,000 cycles little or no deviation from a sinusoidal wave form would be included. However, the extreme upper notes of the organ or piano are used very infrequently and the correct reproduction of their timbre is probably not important. It is doubtful whether many persons could differentiate between say a piano,

flute, and clarinet when listening only to the signal note C⁵.

Although in the case of speech, the ear will reconstruct the fundamental frequency of a tone when the latter has been removed from the reproduction it is doubtful that the same thing applies in the case of music. In any case the practically pure sinusoidal frequencies produced for example by the organ would not be produced at all if below the lower transmission limit.

For the correct reproduction of noises such as tapping, hissing, etc. a very wide frequency range is required and it is in this connection that the ideal range of 30 to 10,000 cycles would probably be found most essential.

Attention should be drawn to one other point in the chart. The mean speech frequency from an articulation standpoint is 1500 cycles. By this it is meant that the removal of all frequencies above 1500 cycles produces the same decrease in articulation as does the removal of all frequencies below 1500 cycles.

The term "Gamut" in the chart on sheet No. 308 is simply the expression used in music for the standard notes of the musical scale.

SETTING RADIO STANDARDS

(Continued from page 110)

to oscillate. The same type of data regarding overloading, quality, selectivity, etc., might be given, but is of detailed interest only for specific cases.

The question as to what the limits should be in a radio receiver cannot be simply answered by stating that sensitivities should be permitted to vary 50 per cent. or that the 60-cycle response must be between 60 and 70 per cent. of that at 400 cycles. Each individual receiver should be made to order following company policies and the standards of the class of units chosen as a relative standard. It has a right to its own reasons for its limits—no group can arbitrarily decide what certain percentage variations in receiver performance are permissible. A high priced set might have close limits, while a change in limits and a reduction of price would make the set a greater profit maker and a better seller. What should the limits be? Fig. 3 shows the sensitivity variation of one design which seems to be a fair compromise between cost and performance. For another design and another price another answer might be obtained.

The whole point to this discussion is that having chosen any particular relative standard as a logical performance possibility, it is the manufacturer's duty to stick to that performance standard as close as is economically possible; that his components should be designed with a particular end in view so that they, too, may share in the honor of reducing the cost; and finally that the limits not be set because the units vary that much, but because the limits are set first in accordance with the company policy, and the set is designed accordingly. These are not mere possibilities, they are workable plans and ably carried out will save money for manufacturer and consumer alike.

ADVERTISE WHAT YOU HAVE TO SELL

(Continued from page 89)

produced. The writer wrote advertisements, letters, and folders. One of his letters sold me a suit, so you see he was good. The tailor made so much money that he bought land in the suburbs, decided there was no fundamental difference between cutting up cloth and cutting up ground, and sold his lots by the same principles that had been so successful in tailoring. Now he's so rich that he doesn't care what happens. My friend, now famous, gets no more free suits, and the tailoring business, deprived of its vitalizing advertising force, is back almost where it started.

It all goes to show that advertising pays when it is properly done. Put the big emphasis on that word "properly," and then when you are tempted to tell somebody exactly how he should advertise, ask yourself how you would like a stranger to tell you how you should advertise.

This is not to say that dealers cannot be of some advertising assistance to manufacturers. For example, dealers know a lot about the effectiveness of the local papers. But the dealer should not try to tell the manufacturer how to advertise.

Only two people are qualified to prepare successful advertising. One is the advertiser himself. The other is an advertising man who has had the benefit of close personal contact with the business, its executives and its products. Experience proves that this advertising man is the better equipped of the two. Neither of these persons can prepare good advertising for a third. In other words, manufacturers are not qualified to do dealer advertising.

NOTE	CYCLES PER SECOND	ORGAN PIPE	REMARKS
C ⁸	32,768		Beyond limit of audibility for average person.
C ⁷	16,384		Telephone silent with 40 volts on receiver terminals.
	10,000		Considered ideal upper limit for perfect transmission of speech and music.
C ⁶	8,192	3/4 in.	Highest note on fifteenth stop.
	5,000		Considered as satisfactory upper limit for high quality transmission of speech and music.
C ⁵	4,096		Highest note of pianoforte.
F ⁴	2,560		Approximate resonant point of ear cavity.
G ⁴	3,072		
	3,000		Considered as satisfactory upper limit for good quality transmission of speech.
C ⁴	2,048		
	2,000		Maximum sensitivity of ear.
	1,500		Mean speech frequency from articulation standpoint.
A ²	850		
A _b ²	800		Representative frequency telephone currents.
F ¹	600		
A ¹	426 2/3		Orchestral tuning. See note below.
C ¹	256		
	200		Considered as satisfactory lower limit for good quality transmission of speech.
C ⁰	128		
	100		Considered as satisfactory lower limit of high quality transmission of speech and music.
E ₀	80		Lower note of man's average voice.
C ₀	64	8 ft.	Lowest note of 'cello.
B ₁	60		
B ₁	32	16 ft.	Lowest note of average church organ.
	30		Considered ideal lower limit for perfect transmission of speech and music.
A ₂	27		Lowest note of pianoforte.
G ₂	25		
C ₂	16	32 ft.	Lowest audible sound. Longest pipe in largest organ.

Notes of the "Gamut" C D E F G A B C
 Vibration frequencies proportional to 1 9/8 5/4 4/3 3/2 5/3 15/8 2
 Intervals between successive notes
 NOTE:— Nearest note is indicated. Scale based on Middle C¹ (Physical Pitch) = 256 ~

Volume vs. Fidelity

PARTICULARLY when reproducing music, the volume of the reception has quite a little to do with the naturalness of the reproduction. The loudness of the sounds influences the fidelity in two ways as explained in the following paragraphs.

In the first place, we should realize that we are accustomed to listen to different types of music—symphonies, jazz, string trios, etc.—at definite levels of volume. If we adjust our set so that the music is not reproduced at a volume of approximately the same level to which we are accustomed, then the reproduction will sound unnatural—in fact, it is unnatural. If we increase the volume so a soloist sounds like an entire orchestra, or decrease the volume so that the boom of the base drum sounds like someone tapping the table with a pencil, we have certainly distorted the original. For most natural reproduction the volume level must appear to the ear to be about the same as the original. The fact that we never increase the volume to such a level because we couldn't

tolerate so much sound in a single room, and because we don't want to annoy our neighbors, does not invalidate the argument.

The second manner in which the reproduction of music at other than normal volume affects the naturalness of the sound is due to the characteristics of the ear. At low volume levels the ear is quite insensitive to high and low audio frequencies but as the volume level is raised the sensitivity of the ear becomes more uniform over the entire range of audio frequencies. The effect of this variation in the characteristic of the ear is such as to cause an apparent loss of low frequencies when the volume is turned down. This probably explains why a loud speaker seems to lose the lows when the volume is turned down—a point about which many experimenters have written us. Probably in almost all cases the loss of lows at low volume is not due to the characteristics of the loud speaker but is simply due, as indicated above, to the characteristics of the ear of the listener.

Wright - De Coster Reproducer

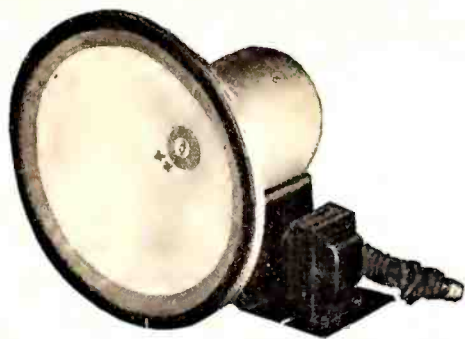

"The Speaker of the Year"

Truly outstanding in purity of tone, volume and fidelity of reproduction is this reproducer.

Cabinets De Luxe



A cabinet of exquisite contour, with a delicately carved grill in acorn and oak leaf motif, against a background of figured cloth of silver bearing the same emblematic design. Legs are of spinnet design and can be sold separately if desired. Dealers can carry a more complete, convenient and less expensive stock by purchasing separate units.

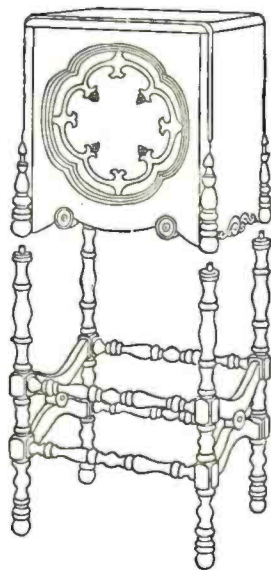

Write for Information

You will receive complete information about both the Wright-De-Coster Reproducer and complete line of cabinets.

WRIGHT-DECOSTER, Inc., 2213 University Ave. St. Paul, Minn.

High Vacuum

"High Vacuum" De Forest Audions contain less than 1-15th the air pressure of other standard tubes.

DE FOREST RADIO CO.
NEW JERSEY
JERSEY CITY

de Forest
AUDIONS

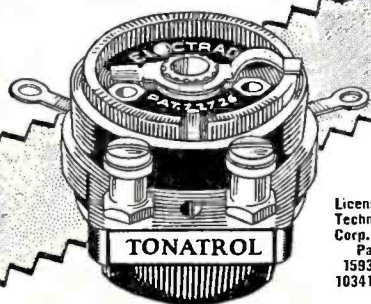

Licensed by
Technidyne
Corp. U. S.
Pats.
1593658-
1034103-04

ELECTRAD TONATROLS

SELL — because BETTER!

SUPERIOR workmanship, smooth performance and longer life. **SELL** the TONATROL line. Careful design, resulting in maximum efficiency and adaptability **KEEPS THEM SOLD**. Exclusive construction. Contact made indirectly with resistance element insuring less wear.

Made in a variety of values for different circuits, with or without filament switch. List \$1.50 to \$3.00.

SUPER-TONATROL

For modern high powered receivers. New type permanent resistance element with pure silver floating contact. Shielded metal construction
List—\$2.40 to \$3.50

175 Varick St., New York, N.Y.
ELECTRAD
INC.

Electrad, Inc., Dept. RB12
175 Varick Street, New York, N. Y.
Send Tonatrol & Super-Tonatrol data.
Name..... Address.....

Read what engineers have to say about Rider's "Trouble Shooter's Manual"



RADIO CORPORATION OF
PENNSYLVANIA
331 Fourth Avenue
Pittsburgh, Pa.

August 23, 1929.

Radio Treatise Co.,
1440 Broadway, New York City
Gentlemen:

We have received John F. Rider's "Trouble Shooter's Manual" which our instructors, who are Westinghouse Electric and Manufacturing Company and Radio Corporation of America engineers, recommend highly and say that all of our radiotician students should have a copy. . . .

Very truly yours,
Radio Corporation of Pennsylvania,
(Signed) W. R. Jones,
Business Manager.

Is a higher recommendation possible? You too, if you are interested in radio and radio service will find Rider's

"TROUBLE SHOOTER'S MANUAL"

of infinite value. Wiring diagrams of more than 200 models of radio receivers . . . Trouble Shooting information. . . How to find the trouble . . . The possible troubles and symptoms in radio frequency amplifiers—detectors—audio frequency amplifiers—A eliminators—B eliminators—a wealth of vital money-making information . . . **THE BOOK WILL BE WORTH HUNDREDS OF DOLLARS TO YOU . . .** 22 chapters of vital information—the kind of dope you need in your service business . . .

Wiring Diagrams of These Commercial Receivers

- | | |
|----------------------|-------------------|
| Radio Corp. of Amer. | Federal |
| Atwater-Kent | Crosley |
| Zenith | Majestic |
| Fada | Stromberg-Carlson |
| Stewart-Warner | Grebe |
| Philco | Freshman |
| Freed-Eiseman | Kolster |
| All-American | Day-Fan |
| Colonial | Workrite |
| Amrad | Sparton |
| Deforest | Ware |
| Garod | Kennedy |
| Operadio | Sleeper |
| Magnavox | Grimes |

240 PAGES 8 1/2" x 11", BLACK STURDITE BINDING

RADIO TREATISE CO.
1440 Broadway, New York City

Send No Money

RADIO TREATISE CO.
1440 Broadway, New York City

Send me John F. Rider's "Trouble Shooter's Manual" and I will pay postman \$3.50 plus a few cents for postage on delivery. It is understood that my money will be refunded if I am not entirely satisfied.

Name.....
Address.....
City..... State.....

ELECTROSTATIC LOUD SPEAKERS

(Continued from page 107)

the loud speaker. The size of the holes in the back plate may also affect the shape of these curves. Such mechanical resonances are very important in the design of electrodynamic and magnetic loud speakers, as well as in the design of electrostatic loud speakers. It is only by proportion of the mechanical and electrical resonances that even response can be obtained.

In drawing conclusions from the tests just described, it must be borne in mind that they apply to a particular type of electrostatic loud speaker tested under particular conditions. Although some of the results apply to all types of electrostatic loud speakers, the authors prefer to limit their conclusions to the particular type in hand.

The results of the investigation so far may be summed up as follows:

1. That the greater part of the sound comes from vibration of the diaphragm over the holes, and that this vibration may be increased or decreased by changing the shape of the holes.

2. That harmonic distortion may be reduced by the use of high bias potentials;

3. That the response of this loud speaker is very uneven as compared to a well-designed standard electrodynamic loud speaker.

4. That it would seem that by proper combination of size of holes, size of back plate, and correct design of input circuit, an electrostatic loud speaker of this type can be designed which will give very even response.

5. That this loud speaker in its present stage of development is inferior to the electrodynamic type in evenness of response, general efficiency, and convenience of operation.

6. That while the results obtained in testing this particular loud speaker show that it is inferior to the electrodynamic type, it should not be thought that it is impractical or that it cannot be designed so as to give good reproduction. As a matter of fact, this particular loud speaker performs much better, and gives much more natural reproduction, than the magnetic loud speakers of only one or two years ago, and in addition it has the advantage of distributing its sound much more evenly than many loud speakers now in use.

GENERAL MOTORS—AND RADIO

(Continued from page 71)

It is pointed out that RCA in absorbing Victor, continued the merchandising policies and avenues of distribution of the old company, while maintaining the separate product and merchandising avenues of the Radiola line. Thus far, this policy has apparently not interfered with either complete line.

Charles F. Lawson, president of Day-Fan, the organization absorbed into General Motors Radio Corporation, has announced to his dealers and distributors: "The enormous advantages which General Motors' backing gives to us—manufacturer, distributor, dealer—are obvious. At once, there is the authority of a great name in engineering, research, and manufacturing behind the claim of excellence in our product. There is the distinct advantage of the General Motors Acceptance Corporation plan of financing deferred payments. Looking to the future, the implications of General Motors' entry in the radio field, with its great resources, are tremendous.

"The Day-Fan dealer franchise is a most valuable one to-day. It is potentially the most important franchise in radio."

Those in the industry who have given serious thought to the implications of the General Motors Radio Corporation's entry into the field, feel that it means first, the coming into radio of a new manufacturing company with ample financing and an important history of experience in mass production, secondly, the entry of skilled merchandising experience suggesting many possible innovations, thirdly, the further extension of radio deferred payment sales through the large resources of General Motors Acceptance Corporation, and fourthly, the probable building up of a new distributing group. Radio is already linked closely to sales outlets for refrigerators, automobiles, and automobile accessories, and it is expected that this new company would not confine its dealer outlets exclusively to those now handling Frigidaire on the one hand or automobiles on the other. It is more likely that the distributing set-up will include outlets from each of these major groups and build up a primary set of radio outlets rather than select one complete ready-made dealer group.

HOUSE-TO-HOUSE SELLING IS NOT A SIDELINE

(Continued from page 86)

That's the outstanding reason why there has been so much unfavorable reaction of late against the method on the part of home owners. It is just as important that the man who represents your store on the outside be as courteous, honest, and fair as those behind the counter."

No matter how many door-to-door men he may employ, however, Mr. Green is firm in his opinion that the store should be the dealer's first consideration. Regardless of the future of the outdoor salesman, the store is practically certain to continue as the backbone of the merchandising structure. Then too, the more attractive and better known the store, the more weight that is added to a salesman's visit to a home.

The better the store the better the chances for success in house-to-house selling—and the better the chance to keep abreast of the merchandising trends of the future.

HOW ABOUT TIME PAYMENTS?

(Continued from page 83)

per cent. of their volume, 38 per cent. report cash sales between 5 and 10 per cent. of volume, 16 per cent. have from 10 to 20 per cent. cash sales, only 8.5 per cent. report 20 to 30 per cent. cash sales, 11 per cent. get from 30 to 50 per cent. cash sales, and 4 per cent. of the dealers reporting have as high as 80 per cent. cash sales.

Seriously, I ask, for the good of the business and of those in it, shouldn't those cash sale figures be going up and up? But, I am sorry to say it looks as though they were not, for in answering the next question—"Are cash sales larger than last year?"—30 per cent. of the dealers say "Yes" and 70 per cent. say "No."

I fancy I can see a bright light in the answers to the last question—"What proportion of your sales do you write off as bad debts?" More than one quarter of the dealers—29 per cent.—say "None" and 38 per cent. say 1 per cent. or less. Glory be! Two thirds of the dealers who report say 1 per cent. or less of bad debts. Looks like a fairly good customer-credit situation.

Straws which indicate which way the breeze blows—that's what these reports mean. Something to think about. Suggestions for a change in practice if it is needed. We cannot take these figures as the last word of authority on common practice. Five hundred dealers were questioned, a lot of dealers to be sure, but a

small proportion of the whole. Not all of them answered, of course.

Accuracy of percentage is not the criterion of this questionnaire. More replies might change these percentages, but I'm sure they wouldn't change the broad high lights of the picture, in which I fancy I see these facts.

(a) It is possible and wise to finance installment sales without loss, and even at a profit for financing as well as for selling.

(b) Customers can and should be made to pay a reasonable price for the very great accommodation of time payments.

(c) Down payments may easily be as high as 25 per cent. or even higher.

(d) The cash sales in the industry are too low in proportion to time sales, particularly till the percentage of cash down on time-payment sales is increased.

(e) The showing in bad debts is one of great credit to the industry.

THE JOBBER'S NEW PLACE

(Continued from page 79)

located in non-competitive neighborhoods.

The unsound and uneconomical elements of long terms and credit losses will be practically nil. Equally out of date will be the practice of having eleven jobbers' salesmen all undertaking to sell a quarter of a case of a standard brand of soap or milk to a retailer whose credit is Z-blank.

The independent retailer will have changed his mind about not letting his jobber tell him what to buy and what to sell. He will no longer take the position that he is an independent business man who can go broke any time he wants to and nobody can stop him. Such an individual will have a hard time finding a jobber who will work with him.

In brief, the jobber of 1935 will have practically as close supervision over his retailers as the chain-store management has over its units. The outstanding difference will be that when the contract which the retailer has signed expires, he will be free to sign up with another jobber.

The great difference between the individual retailer of 1935 and the individual retailer of to-day will be that the 1935 model will be in position to merchandise right along with anybody else in his neighborhood.

All in all, it is safe to say that the lot of the individual retailer in 1935 is going to be much happier and more profitable than it is now. The manufacturer of drug sundries, dry-goods products—he'll have a new worry. These combinations of wholesalers and their groups of retailers, buying, selling, merchandising, and advertising as large groups will do some interesting things in the way of pushing private brands.

They'll go just as far in this direction as proves profitable. They will attack in the weakest spots. They will take hold of a kind of product which is not dominated by one or more well-advertised brands which have the popular demand and put back of such items a much more intelligent sales effort than they have thus far been able to provide.

The turmoil and tumult of 1920 to 1930 will have quite definitely subsided by 1935. The spread between the actual cost of the product on the manufacturer's floor and the price paid for it by the ultimate consumer will have shrunk materially.

There will be little difference, so far as the consuming public is concerned, between the individually owned stores and the units belonging to chains, except that the individually owned stores will be in position to exert more latitude, more individualism, be more in tune with their immediate neighborhood than the chain-store unit.

RADIO Isn't Modern Without Automatic VOLTAGE CONTROL

See that the electric radio you buy or build is equipped for the AMPERITE Self-Adjusting LINE VOLTAGE CONTROL. Prevents noisy voltage fluctuations. Improves Reception — Saves Tubes.

Write for Useful Bulletin. Address Dept. R B 12

AMPERITE Corporation
561 BROADWAY, NEW YORK

AMPERITE Self-Adjusting LINE VOLTAGE CONTROL

Why not subscribe to Radio Broadcast? By the year only \$4.00; or two years \$6.00, saving \$2.40. Send direct to Doubleday, Doran & Co., Inc., Garden City, New York.

STATEMENT OF THE OWNERSHIP, MANAGEMENT, CIRCULATION, ETC., required by the Act of Congress of August 24, 1912, of RADIO BROADCAST, published monthly at Garden City, New York, for October 1, 1929. State of New York, County of Nassau.

Before me, a Notary Public in and for the State and County aforesaid, personally appeared John J. Hessian, who, having been duly sworn according to law, deposes and says that he is the treasurer of Doubleday, Doran & Co., Inc., owners of Radio Broadcast and that the following is, to the best of his knowledge and belief, a true statement of the ownership, management (and if a daily paper, the circulation), etc., of the aforesaid publication for the date shown in the above caption, required by the Act of August 24, 1912, embodied in section 411, Postal Laws and Regulations, printed on the reverse of this form, to wit:

1. That the names and addresses of the publisher, editor, managing editor, and business managers are: *Publisher*, Doubleday, Doran & Co., Inc., Garden City, N. Y.; *Editor*, Willis Kingsley Wing, Garden City, N. Y.; *Business Managers*, Doubleday, Doran & Co., Inc., Garden City, N. Y.

2. That the owner is: (If owned by a corporation, its name and address must be stated and also immediately thereunder the names and addresses of stockholders owning or holding one per cent. or more of total amount of stock. If not owned by a corporation, the names and addresses of the individual owners must be given. If owned by a firm, company, or other unincorporated concern, its name and address, as well as those of each individual member, must be given.) F. N. Doubleday, Garden City, N. Y.; Nelson Doubleday, Garden City, N. Y.; George H. Doran, 244 Madison Avenue, N. Y. C.; Russell Doubleday, Garden City, N. Y.; John J. Hessian, Garden City, N. Y.; W. Herbert Eaton, Garden City, N. Y.; Henry L. Jones, 244 Madison Avenue, N. Y. C.; Donald Macdonald, Garden City, N. Y.; Harry E. Maule, Garden City, N. Y.; William J. Neal, Garden City, N. Y.; Daniel W. Nye, Garden City, N. Y.; Reginald T. Townsend, Garden City, N. Y.; Dorothy D. Babcock, Oyster Bay, N. Y.; Alice DeGraff, Oyster Bay, N. Y.; Florence Van Wyck Doubleday, Oyster Bay, N. Y.; Janet M. Doubleday, Glen Cove, N. Y.; S. A. Everitt, Huntington, N. Y.; E. French Strother, Garden City, N. Y.; George H. Doran, Trustee for Mary Noble Doran, 244 Madison Avenue, N. Y. C.; F. N. Doubleday or Russell Doubleday, Trustee for Florence Van Wyck Doubleday, Garden City, N. Y.; S. A. Everitt or John J. Hessian, Trustee for Josephine Everitt, Garden City, N. Y.

3. That the known bondholders, mortgagees, and other security holders owning or holding 1 per cent. or more of total amount of bonds, mortgages, or other securities are: (If there are none, so state.) NONE.

4. That the two paragraphs next above, giving the names of the owners, stockholders, and security holders, if any, contain not only the list of stockholders and security holders as they appear upon the books of the company but also, in cases where the stockholder or security holder appears upon the books of the company as trustee or in any other fiduciary relation, the name of the person or corporation for whom such trustee is acting, is given; also that the said two paragraphs contain statements embracing affiant's full knowledge and belief as to the circumstances and conditions under which stockholders and security holders who do not appear upon the books of the company as trustees, hold stock and securities in a capacity other than that of a bona fide owner; and this affiant has no reason to believe that any other person, association, or corporation has any interest direct or indirect in the said stock, bonds, or other securities than as so stated by him.

(Signed) DOUBLEDAY, DORAN & COMPANY, INC.
By John J. Hessian, *Treasurer*.

Sworn to and subscribed before me this 17th day of September, 1929.

[SEAL]

(Signed) Frank O'Sullivan

Notary Public Queens County No. 1501
Certificate filed in Nassau County
Term expires March 30, 1930

ACTRON

RADIO TUBES

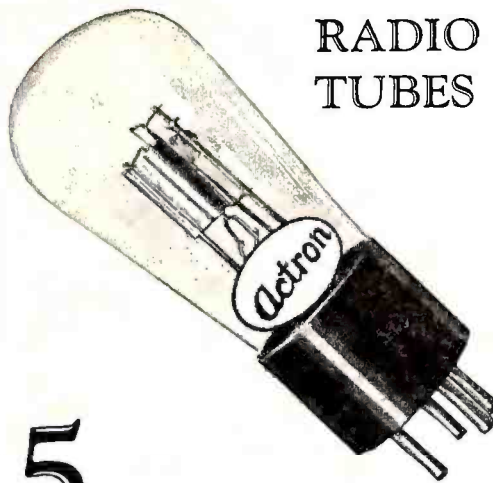

5 Reasons for Actron's nation-wide popularity

Tone quality

Long life

Uniformity

Non-microphonic

Finest processes of manufacture

Call your Jobber or write us direct for complete ACTRON dealer information.

The ACTRON CORPORATION
123 N. SANGAMON ST.
CHICAGO, ILL.

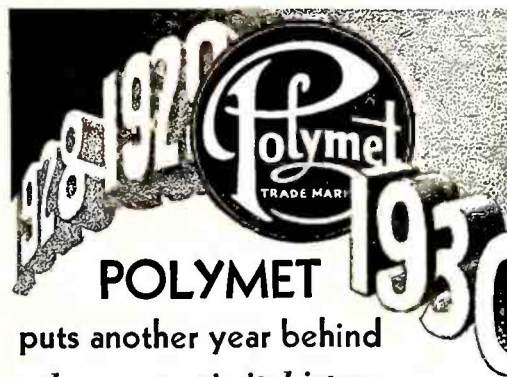

puts another year behind
—the greatest in its history

Over 80% of all the radio manufacturers turned to Polymet in 1929 for standard radio essential parts.

Starting right where 1929 leaves off, Polymet will strive in 1930 to occupy an even more dominating position in the radio parts industry, by continuing to offer the same unapproachable Quality, incomparable Service, and unexampled Dependability in

CONDENSERS
RESISTANCES
COILS
and other

POLYMET PRODUCTS

Polymet Manufacturing Corp.
837 East 134th Street New York City

Here's the Answer

to every question about the principles, methods, or apparatus of radio transmitting and receiving. A Complete Course in Radio Operation in a Single Volume.

THE RADIO MANUAL

A New Edition

Complete new chapters on aircraft radio equipment; Practical Television and Radiomovies with instructions for building a complete outfit; radio interference; 100% modulation; latest equipment of the Western Electric Co.; the Marconi Auto-Alarm System; and many other developments of the past year. All this information is added in the new edition and, besides, the entire book has been brought right up to date with much new material. *The Radio Manual* continues to be the one complete and up-to-the-minute handbook covering the entire radio field.

A Handbook for
Students
Amateurs
Operators
Inspectors



20 big chapters cover: Elementary Electricity and Magnetism; Motors and Generators; Storage Batteries and Charging Circuits; The Vacuum Tube; Circuits Employed in Vacuum Tube Transmitters; Modulating Systems and 100% Modulation; Wave-meters; Piezo-Electric Oscillators; Wave Traps; Marine Vacuum Tube Transmitters; Radio Broadcasting Equipment; Arc Transmitters; Spark Transmitters; Commercial Radio Receivers; Marconi Auto-Alarm; Radio Beacons

and Direction Finders; Aircraft Radio Equipment; Practical Television and Radiomovies; Eliminating Radio Interference; Radio Laws and Regulations; Handling and Abstracting Traffic.

An immense amount of information never before available including detailed descriptions of standard equipment is presented.

Prepared by Official Examining Officer

The author, **G. E. Sterling**, is Radio Inspector and Examining Officer, Radio Division, U. S. Dept. of Commerce. The book has been edited in detail by **Robert S. Kruse**, for five years Technical Editor of QST, the Magazine of the American Radio Relay League. Many other experts assisted them.

Free Examination

The new edition of "The Radio Manual" has just been published. Nearly 900 pages. 369 illustrations. Bound in Flexible Fabrikoid. The coupon brings the volume for free examination. If you do not agree that it is the best Radio book you have seen, return it and owe nothing. If you keep it, send the price of \$6.00 within ten days.

Order on This Coupon

D. Van Nostrand Co., Inc.,
250 Fourth Ave., New York

Send me the Revised edition of THE RADIO MANUAL for examination. Within ten days after receipt I will either return the volume or send you \$6.00, the price in full. (Radio Broadcast 12-29)

Name.....

St. & No.

City and State.....

**A Simplified
"MORECROFT"**

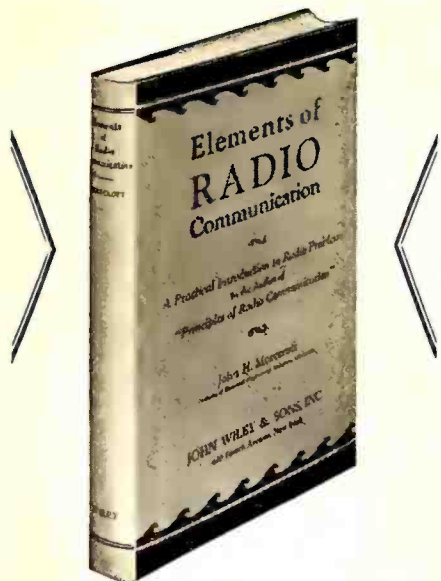

**Elements of
Radio
Communication**

By **JOHN H. MORECROFT**
*Professor of Electrical Engineering,
Columbia University*

For several years Morecroft's "Principles of Radio Communication" has been recognized as the last word on the subject. But as it is highly technical, there have been many suggestions to the effect that a similar but shorter and simplified work would be welcomed by thousands of people.

In response to this, Professor Morecroft has just written "Elements of Radio Communication." It embraces all the major features of the larger work, but it is treated in a much simpler fashion. While technical, it requires no mathematical training further than a knowledge of elementary algebra. The whole field of radio is discussed from broadcasting to receiving, and the latter from a simple crystal set to the most modern A.C. operated receiver. Also, the book is completely illustrated with charts and diagrams, and is supplemented with sets of problems taken from actual radio circuits and apparatus.

Let a free examination convince you that "Elements" furnishes an ideal introduction to radio.

Price \$3.00

A Wiley Book

FREE EXAMINATION COUPON

JOHN WILEY & SONS, Inc.
440 Fourth Avenue, New York

Gentlemen: Kindly send me on ten days' examination Morecroft's "Elements of Radio Communication." I agree to remit the price of the book within ten days after its receipt or return it postpaid.

Name.....

Address.....

Position or Reference.....

Subscriber Yes No..... RB 12-29

**CHANGING SALES
CONDITIONS**

(Continued from page 73)

plainly told that static will occasionally prove annoying on any set they might buy; that good long distance reception is the exception rather than the rule, and that no radio is immune from local interference. The company has found that customers appreciate frankness in these respects.

When a new man is hired, Mr. Moore instructs him clearly and concisely with regard to the firm's policies. There is none of this "turning a man loose" to do as he pleases and in his own fashion.

Whenever a new model appears—and at any other time there may be occasion for it—a sales meeting is held. The features of the sets are pointed out one by one and Mr. Moore shows how they should be sold. Representatives of manufacturers and wholesalers are also asked to talk before these meetings occasionally as one of the best means of keeping the Universal salesmen strictly up to the minute.

Highly important in the handling of salesmen, says Mr. Moore, is in giving them a real incentive to put forth their best efforts. He believes that the commission method of paying men offers the best solution—providing the dealer's responsibility in the men does not cease with the mere offer of payment in case they produce. Hence, Universal salesmen are paid 10 per cent. commission on sales against a drawing account of \$40 a week. They also receive carfare for their work.

There is another important factor about Mr. Moore's method of paying his men. Fifteen per cent. of every 10 per cent. commission is held back by the company for three months until a fund of \$100 has been created in the salesman's favor. This has proved an effective and adequate guarantee against forced sales on the instalment plan where the customer's reluctance to meet payments might not be discovered for several months.

The Universal Radio Company wants its men to feel a direct responsibility in every sale they make. It is not taken for granted that salesmen call back at the home of every customer after sets have been in operation a couple of weeks, reports being necessary in every instance. This practice pleases the customer, insures successful operation of sets and results in obtaining new prospects.

ROBERT S. KRUSE

Consultant and Technical Writer

103 Meadowbrook Road, West Hartford, Conn.
Telephone Hartford 45327

A Radio Parts Guide

THE NEW

YAXLEY

Catalog

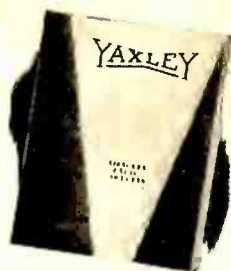

Send for it today for complete listings of Radio Convenience Outlets, Connector Plugs, Rheostats, Fixed and Grid Resistances, Jacks, Jack Switches, Phone Plugs, etc.

YAXLEY MFG. CO.

Dept. B, 1528W Adams St., Chicago, Ill.



**AUDIO
TRANSFORMERS**

*Worthy of the
HAMMARLUND
Name Plate*

DESIGNED primarily for the new "HIQ-30" Custom-Built Receiver, Hammarlund Transformers are a revelation in amplifying power and tone fidelity over the entire audible frequency range. The large cross-section core of specially treated laminations permits high primary currents without saturation. Completely shielded. Pigtail terminal leads for sub-panel connection.

Four types: First stage, Push-Pull Input, Push-Pull Output for magnetic speakers, Push-Pull Output for dynamic speakers. Hear them! Try them! They will greatly improve the output from any circuit.

Write Dept. RB-12 for Details

HAMMARLUND MFG. CO.

424-438 W. 33rd St., New York

**For Better Radio
Hammarlund
PRECISION
PRODUCTS**

For Sale

Western Electric Type 1-A
500 Watt Transmitter

Western Electric Type 1-B
Power Panel

Western Electric Type 8-A
Speech Amplifier

Western Electric Motor
Generator, System to supply
1-A Transmitter including
antenna equipment
and tower.

**Fleetwood Hotel
Miami Beach, Florida**

The *Wonder Plant* of the Radio Speaker Industry

A battery of these big presses make possible the economical "SYMINGTON" speaker design, stamping from heaviest sheets those metal parts ordinarily cast or completed by the assembly of several sections.

VISITORS at the mammoth speaker plant of Valley Appliances, Inc., at Rochester, New York, marvel first at its size, then at its completeness, finally at the precision of its product, the Symington Reproducer.

In this plant, Valley Appliances, Inc. utilizes over \$1,000,000 in plant and equipment for the production of Symington Reproducers. \$348,000 of modern labor-saving machinery has been added in the last three years.

We have just published a pictorial folder showing the big Valley Plant at work. It shows our large-scale One-Profit plant from Laboratory to Loading Platform. Executives and Engineers are invited to send for a copy.

*No charge
or obligation.*

**VALLEY
APPLIANCES, INC.**

*Makers of the
Symington Reproducer*
ROCHESTER, N. Y.

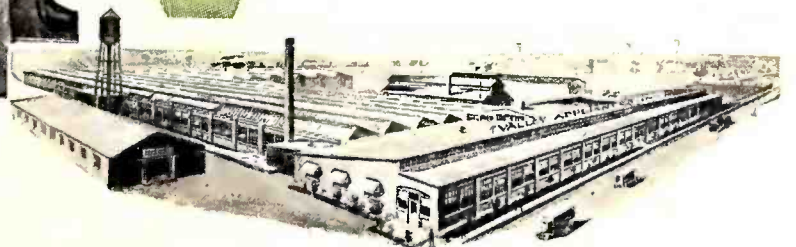
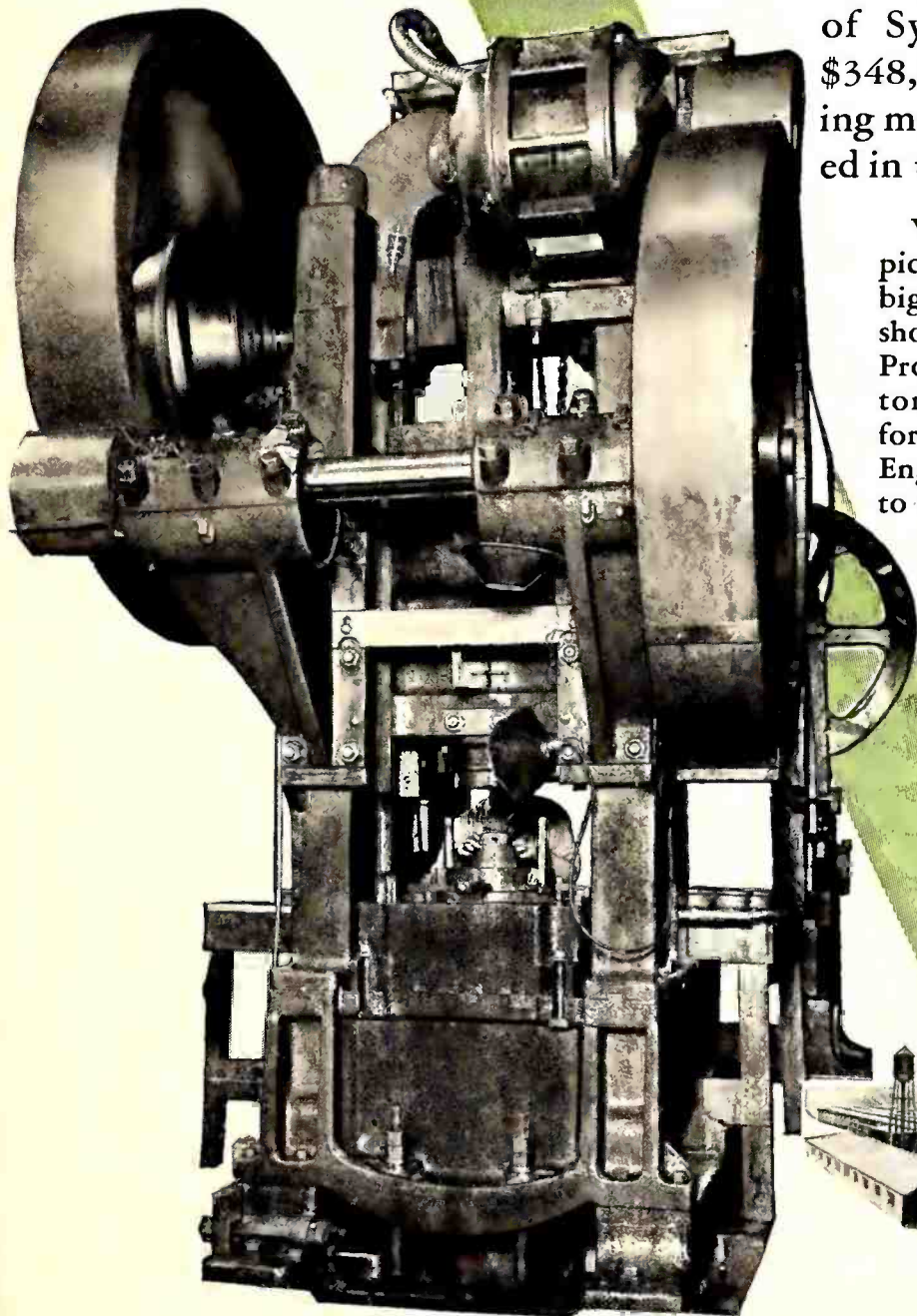

The Fastest Horse Is Always the Best Bet



THE CONCERT GRAND, illustrated, is of beautiful and unusually substantial construction. Four-way matched butt walnut, carefully selected oriental walnut panels, the right amount of birds-eye maple, all contribute to make it an outstanding cabinet. Priced absolutely complete, less only tubes . . . \$173. Other models \$160 and \$195. All prices higher west of the Rockies.

WHY is it that out of hundreds of radio sets on the market,

ONLY ONE bases its campaign on direct comparative tests that can be made anywhere, by anyone, without laboratory instruments—definite tests that really mean something—and gives away through dealers millions of circulars telling plainly how to make these tests on any radio?

ADJECTIVES help to sell goods, without a doubt. We know some good ones, too. And we have plenty of celebrity endorsements—not baseball celebrities, but famous musical authorities. And there's a heavier advertising appropriation with every SILVER RADIO than with any other make we know. And yet, for all that, we say and believe—

"In the hard-fought radio market of 1929-30, the safest investment on any dealer's floor is a receiver that will consistently outperform all competitive makes irrespective of price."

Your SILVER RADIO distributor stands squarely back of the claim here implied. Make him prove it!

SILVER-MARSHALL, Inc., 6443 W. 65th St., Chicago



SILVER
Radio

SILVER · ON · RADIO · LIKE · STERLING · ON · SILVER